



MANCHESTER Series

MV210-HC

Full Size Dual 10" Hybrid Curve Element for Install and Touring

MS121

Single 21" Front Loaded Subwoofer for Touring and Install Applications

MAN210-FG

Universal Fly Grid for MANCHESTER MV210-HC Array Elements and MS121 subwoofers

MV210-VT

Vertical Transporter for 4 MANCHESTER MV210-HC Line Array Elements

MS121-VT

Vertical Transporter for MANCHESTER MS121 Subwoofers

EN

EN Safety Instruction

1. Read these instructions.
2. Keep these instructions.
3. Heed all warnings.
4. Follow all instructions.
5. Do not use this apparatus near water.
6. Clean only with dry cloth.
7. Do not block any ventilation openings. Install in accordance with the manufacturer's instructions.
8. Do not install near any heat sources such as radiators, heat registers, stoves, or other apparatus (including amplifiers) that produce heat.
9. Use only attachments/accessories specified by the manufacturer.



10. Use only with the cart, stand, tripod, bracket, or table specified by the manufacturer, or sold with the apparatus. When a cart is used, use caution when moving the cart/apparatus

combination to avoid injury from tip-over.



11. Correct disposal of this product: This symbol indicates that this product must not be disposed of with household waste, according to the WEEE Directive (2012/19/EU) and your national law. This product should be taken to a collection center licensed for the recycling of waste electrical and electronic equipment (EEE). The mishandling of this type of waste could have a possible negative impact on the environment and human health due to potentially hazardous substances that are generally associated with EEE. At the same time, your cooperation in the correct disposal of this product will contribute to the efficient use of natural resources. For more information about where you can take your waste equipment for recycling, please contact your local city office, or your household waste collection service.

12. Do not install in a confined space, such as a book case or similar unit.

13. Do not place naked flame sources, such as lighted candles, on the apparatus.

LEGAL DISCLAIMER

Music Tribe accepts no liability for any loss which may be suffered by any person who relies either wholly or in part upon any description, photograph, or statement contained herein. Technical specifications, appearances and other information are subject to change without notice. All trademarks are the property of their respective owners. Midas, Klark Teknik, Lab Gruppen, Lake, Tannoy, Turbosound, TC Electronic, TC Helicon, Behringer, Bugera, Aston Microphones and Coolaudio are trademarks or registered trademarks of Music Tribe Global Brands Ltd. © Music Tribe Global Brands Ltd. 2023 All rights reserved.

LIMITED WARRANTY

For the applicable warranty terms and conditions and additional information regarding Music Tribe's Limited Warranty, please see complete details online at community.musictribe.com/pages/support#warranty.

Welcome

Thank you for choosing a Turbosound loudspeaker product for your application. If you would like further information about this or any other product, please visit our website at [turbosound.com](https://www.turbosound.com).

Unpacking the Loudspeaker

After unpacking the unit, please check carefully for damage. If damage is found, please notify your supplier at once. You, the consignee, must instigate any claim. Please retain all packaging in case of future return shipment.

System Requirements

The MV210-HC is a bi-amp 3-way loudspeaker with a passive crossover used on the mid and high frequency bands. It requires 2 channels of amplifier and DSP. With these Lake XP-based pre-sets, the Module Output Mixing (MoM) setup is no longer used, but instead, these pre-sets utilize the 3 band Multiband on each of the Module outputs.

The MS121 subwoofer requires 1 channel of amplifier and DSP for normal forward firing operation. Cardioid bass set ups will require additional amplifier and DSP channels.

All Manchester series Loudspeakers exclusively use LAKE pre-sets via Lab Gruppen PLM+ and D series L platforms. No other amplifier and DSP platforms are supported.

Manchester series has a powerful yet simple pre-set strategy utilizing the latest functionality of LAKE software, along with new acoustic compensation for length of array and throw distances required (explained later in this QSG).

Pre-set data is found either via the Lake Load Library or can be downloaded from www.turbosound.com

Recommended Lab Gruppen PLM+ models for Touring applications are the PLM12k44 and PLM20k44.

For installations using Lab Gruppen D series L models, please use Lab Gruppen 'CAFE' software - available for download from www.labgruppen.com - to determine the optimum amplifier configuration for your system.

System Cabling Requirements

To avoid wasting amplifier power, you should use heavy-duty speaker cable with a minimum wire size of 2.5 mm² (14 AWG), and preferably 4 mm² (12 AWG) for longer runs or where total cabinet input impedance is less than 8 ohms. For extreme cable lengths, be aware of cable impedance and resistive losses. Always observe the correct polarity.

Use genuine NEUTRIX SPEAKON CONNECTORS for reliable operation.

EN

Subwoofer Cabling

NOTE: Since the MS121 subwoofer is wired 1+/- = LF and 2+/- = LINK, in order to power multiple MS121 enclosures, it is advised to construct SUB LINK cables wired: 2+ -> 1+ and 2- -> 1-.

To power two subwoofers per amplifier channel, standard NL4 link cables from Lab Gruppen bi-wired NL4 outputs (Channel 1 = 1+/-; Channel 2 = 2+/-) can be used in conjunction with a SUB LINK cable. Refer to wiring diagrams below for further details.

To power one subwoofer per amplifier channel, a single NL4 cable from Lab Gruppen bi-wired NL4 outputs (Channel 1 = 1+/-; Channel 2 = 2+/-) connects to the first subwoofer, then the SUB LINK cable connects to the second subwoofer.

Two Subwoofers Per Amplifier Channel

LAB GRUPPEN PLM+ Series Amplifier outputs configured in LAKE software on pins 1 +/- and 2 +/-

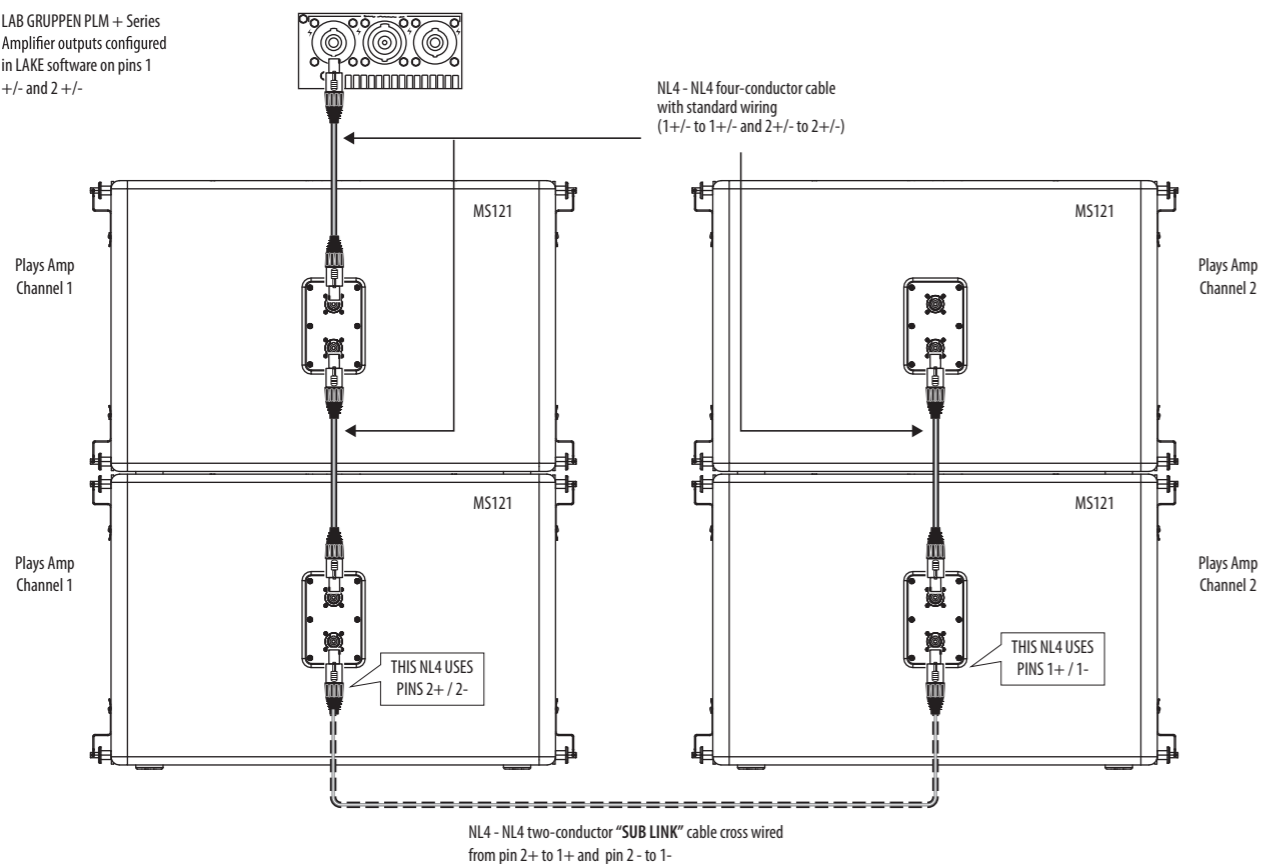

Cardioid BFF (back, forward, forward) Using 4-Core NL4 cable, 2 DSP and 2 amplifier channels

LAB GRUPPEN PLM+ Series Amplifier outputs configured in LAKE software on pins 1 +/- and 2 +/-

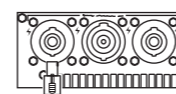

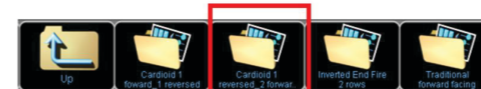

All cables are NL4 - NL4 four-conductor with standard wiring (1+/- to 1+/- and 2+/- to 2+/-)

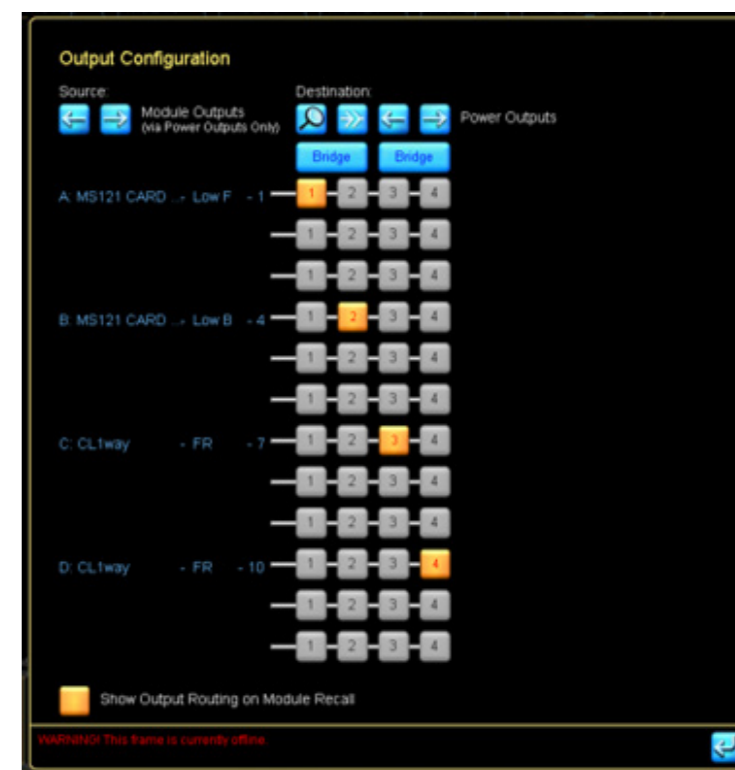
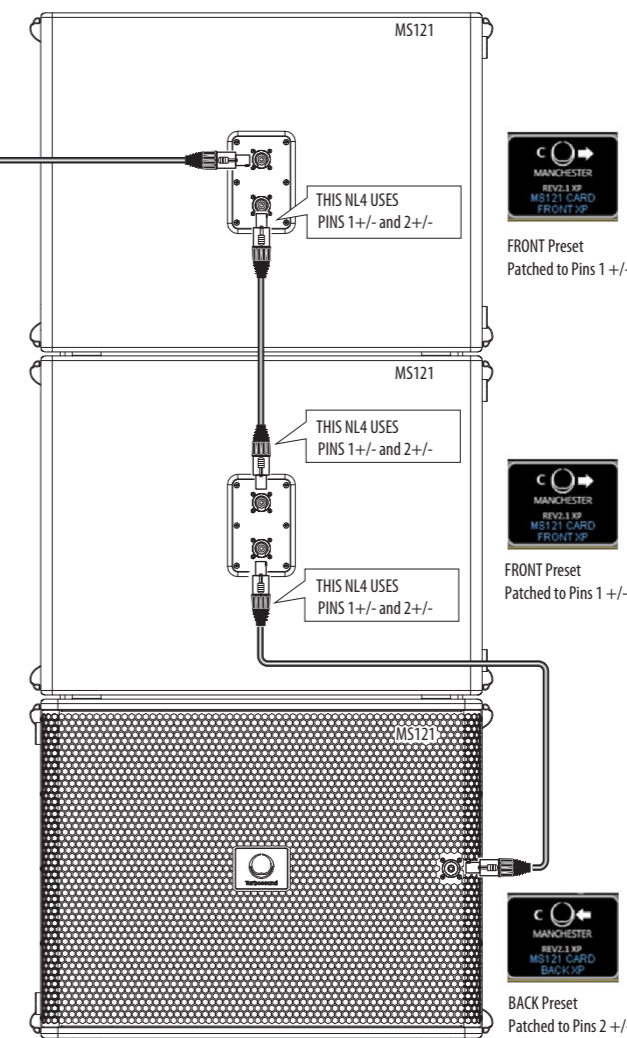

Cardioid:
1 Reversed
2 Forward

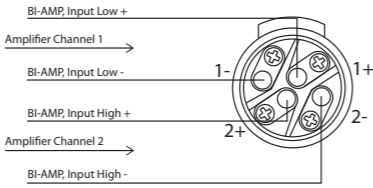
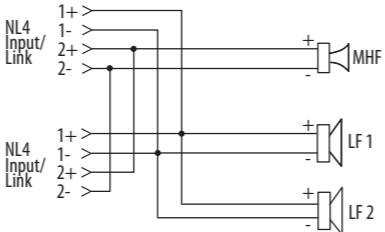

Connections

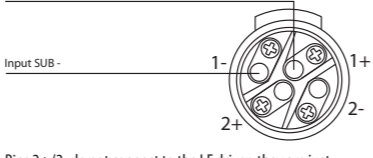
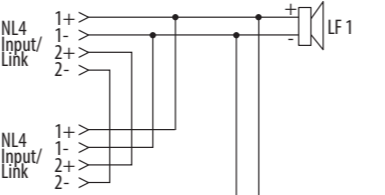
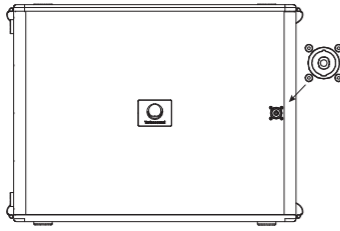
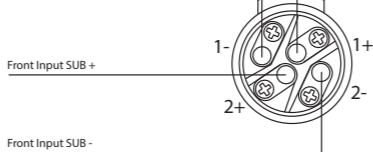
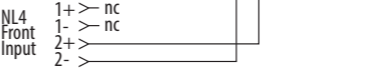
Mode	Back Panel and Front Panel	Connector	Internal Schematic
MV210-HC			
MS121 rear panel		 <p>Pins 2+/- do not connect to the LF driver, they are just used to link.</p>	
MS121 front panel			

Rigging and Acoustic Simulation Software

Refer to the MAN210-FG rigging manual for safe suspension and installation of the loudspeakers, fly grid and all suspension hardware.

MANCHESTER Series loudspeakers and fly grid are designed and tested to strict BGV-C1 standards. Suspension of these speakers must be performed in accordance with the MAN210-FG fly grid rigging manual available online at turbosound.com

EASE Focus 3 is an acoustic simulation program, available as a free download from <https://www.afmg.eu/en/ease-focus>

Full EASE data can be downloaded from www.turbosound.com
This will allow acoustic prediction, array formation and suspension to be determined. Important safety information about WLL is also calculated by EASE Focus.

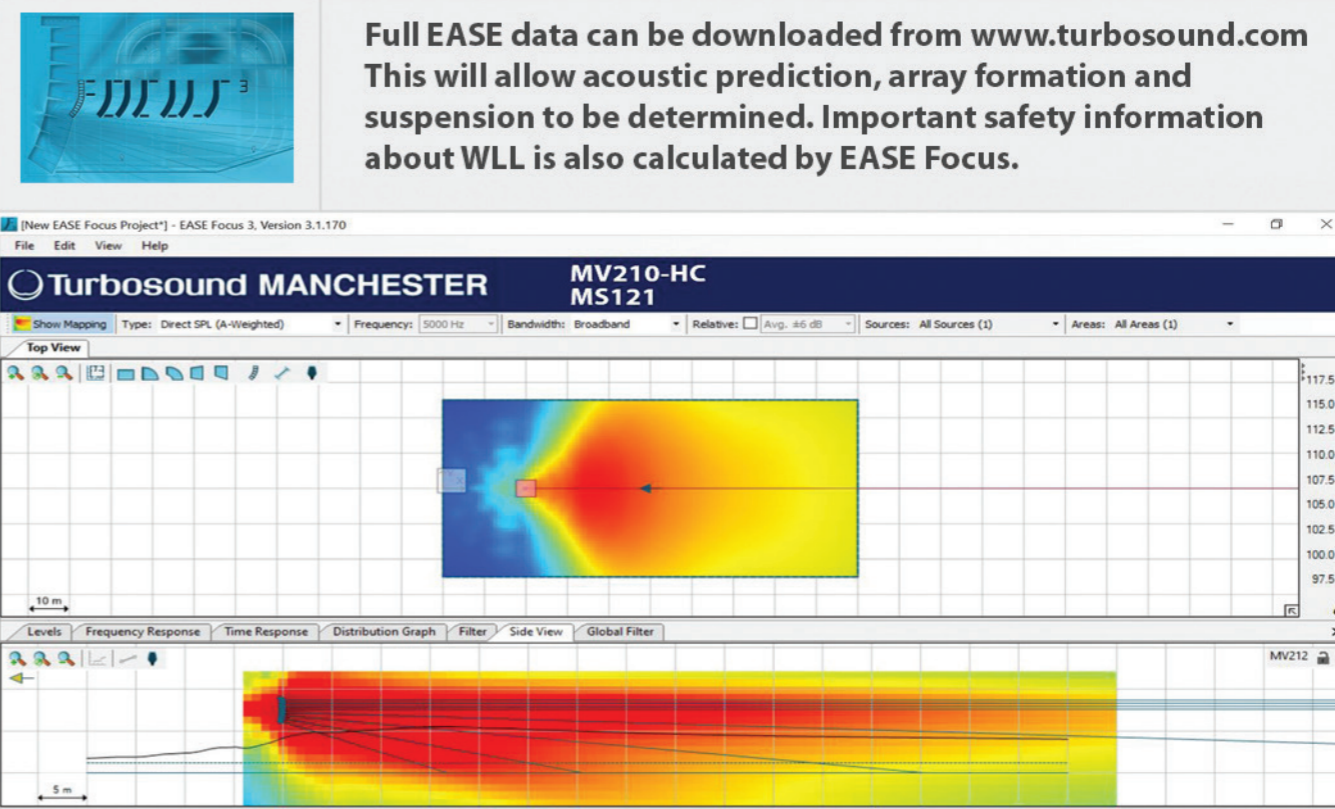

[New EASE Focus Project] - EASE Focus 3, Version 3.1.170
 File Edit View Help
Turbosound MANCHESTER MV210-HC MS121
 Show Mapping Type: Direct SPL (A-Weighted) Frequency: 5000 Hz Bandwidth: Broadband Relative: [Avg. #6 dB] Sources: All Sources (1) Areas: All Areas (1)
 Top View
 Levels Frequency Response Time Response Distribution Graph Filter Side View Global Filter
 X=64.95 m Y=0.00 m Z=5.07 m Level=116.9 dB Input Voltage: 47.2 dBV (Max: 47.2 dBV)

Suspended Arrays

! Safety Warning: Only authorised and certified personnel shall design and install suspended configurations, following the instructions and procedures in the MAN210-FG fly grid rigging manual available online at turbosound.com. For maximum array sizes, weights and working load limits, please consult this rigging manual. Failure to follow these instructions may lead to death or permanent injury.

The versatile MAN210-FG fly grid allows the Manchester MV210-HC and MS121 speakers to be flown in a number of different configurations.

The MAN210-FG comes with a multi-pick point tip bar for single or dual suspension.

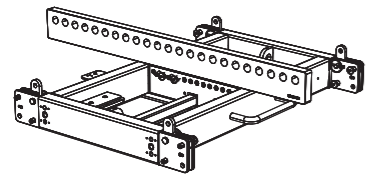

The MAN210-FG also comes with a single pick point plate that may be used instead of the tip bar.

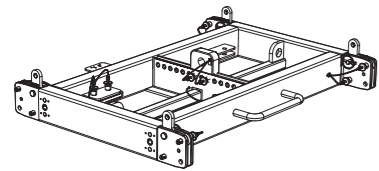

The MAN210-FG also comes with side support 'outriggers' with adjustable feet to aid stability, for forward or rearward array tilt. A ground stack plate attaches to the rear mounting point on MV210-HC speakers for ground stacking.

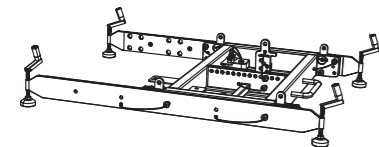

MV210-HC Array Example

MV210-HC speakers attached to the MAN210-FG Fly Grid. The MV210-HC rear mounting plates adjust the angles.

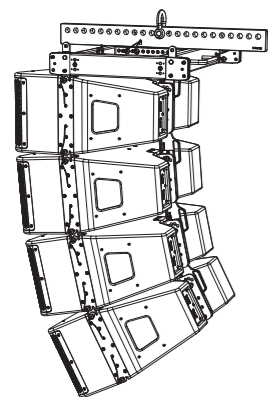

Subwoofer Array Example

Two MS121 subwoofers attached to an MAN210-FG fly grid. The subwoofers can also be mounted rear-firing.

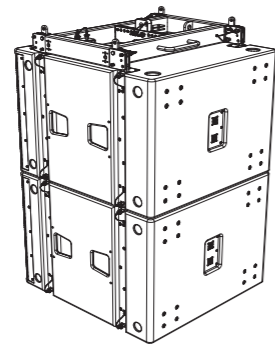

Hybrid Array Example

A second MAN210-FG is attached to the bottom of the lower MS121 subwoofer. MV210-HC speakers can then be attached to this lower fly grid.

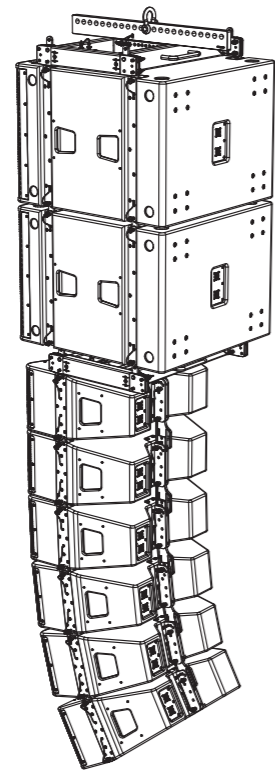

Ground Stacking

! Safety Warning: Only authorised personnel shall design and rig the ground stacked configuration, following the instructions and procedures in the MAN210-FG fly grid rigging manual available online at turbosound.com. Failure to follow these instructions may lead to death or permanent injury.

MV210-HC Groundstack Example

The MAN210-FG fly grid comes with a ground stack plate that attaches to the rear mounting point on the lowest MV210-HC. Two outriggers with adjustable feet offer extra stability and support. The outriggers can be fitted in three positions, depending on if the array is tilted forward, upright, or tilted back.

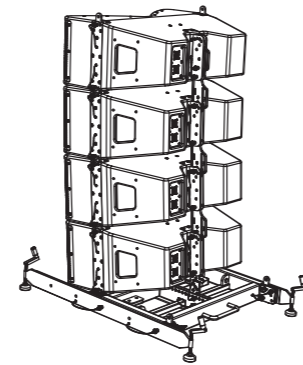

Hybrid Groundstack Example

The MAN210-FG fly grid may be connected to the top of an MS121 subwoofer, and then MV210-HC speakers connected to the top of the fly grid.

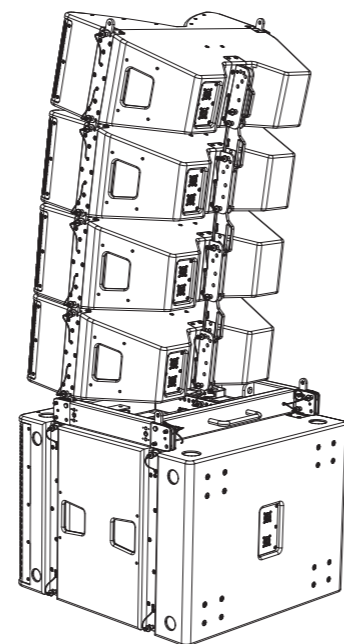

Lake Preset Overlays and Application Notes

All Manchester series Loudspeakers exclusively use Lake XP pre-sets via Lab Gruppen PLM+ and D series L platforms. No other amplifier and DSP platforms are supported.

The Manchester series has a powerful yet simple pre-set strategy utilizing the latest functionality of Lake software, along with new acoustic compensation overlays for length of array and throw distances required.

Pre-set data is found either via the Lake Load Library, or can be downloaded from www.turbosound.com

MV212, MV212-XV, MV210-HC & MC12-P loudspeakers each have individual Bi-AMP FIR base pre-sets: Full range with or without MS Subwoofers.

* MC12-P also have bi-amp (2 channel DSP/AMP) and passive (1 channel DSP/AMP).

CAUTION: Do not combine MV212 / MV212XV / MV210-HC / MC12-P loudspeakers on the same amplifier / DSP circuit. Failure to follow these instructions may lead to damage to the equipment.

CAUTION: Pay careful attention to output patching.

MV212, MV212-XV, MV210-HC, MC12-P, MS Subwoofer modules are based on the XP module from Lake software.

This QSG refers to REV2.1 XP presets.

CAUTION: REV1.1 (older 'FIR3way' modules) and REV2.1 XP modules ARE NOT COMPATIBLE IN THE SAME SYSTEM.

Lake software V7.0.7 or above must be used.

Lake XP signal flow:

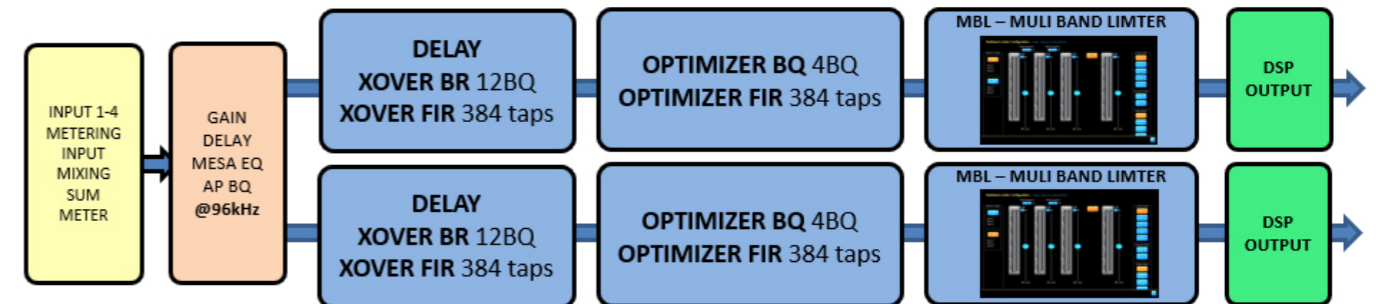

The download of the Lake controller includes the Lake Controller Operation Manual, which is a full tutorial of the Lake Controller and compatible hardware such as PLM+ series amplifiers

Within this QSG, we focus on the Turbosound Manchester series workflow and pre-set strategy, and assume basic working knowledge of the Lake Controller.

DESCRIPTION

1.1: Frame (Amplifier) is in the Main workspace page
Here we can see a default PLM12k44 frame with no DSP pre-set modules loaded.

OVERLAY

How to load a module from the Lake Load Library:
Left-click on Module A in the frame.

Module A is now outlined in yellow, and the buttons at the bottom of the workspace show various module options. The Modules button is also highlighted there.

OVERLAY

To Load a module :
Click the 'Module Store/Recall' button.

OVERLAY

DESCRIPTION

Folders now appear, and these allow you to select where to recall the module (pre-set) from.
Double click the "Lake Load Library 5.5" folder.

OVERLAY

Scroll using the arrow keys >> << along the bottom, to find the "Suitable for TURBOSOUND Loudspeakers" folder, then double click to open it.

OVERLAY

Now scroll again >> << to find the "Manchester REV2.1 XP" folder, then double click to open it.

CAUTION: Do not open the "Manchester" folder as this may contain older REV1.1 FIR3way modules which are replaced by REV2.1 XP in October 2022. Note that this QSG only refers to the REV2.1 XP module.

OVERLAY

DESCRIPTION

Three folders appear. Double click "Modules"

CAUTION: Do not open "Array Size Comp" or "Distance EQ" yet. These are EQ overlays, explained later in this QSG.

OVERLAY

The available module folders are displayed.

Left-click on any of these to show more details about the module set up.

TIP: Please read the information!

Double-clicking the 'modules' folder will open the module pre-set in the highlighted module of the Frame (amplifier)

DESCRIPTION

OVERLAY

Press 'YES' to proceed –the selected pre-set module is loaded!

DESCRIPTION

OVERLAY

DESCRIPTION

Output Configuration:

Now you can patch the DSP module output to the frame's amplifier outputs

For this Module we want Low to pins 1 and high to pins 2. The patch is highlighted in yellow boxes with red text

Once you have finished the correct output patch, press enter to close the output configuration

Note: you will get access to the screen once you go through the same process to load other pre-set modules into the free C & D modules or via the IO option button

OVERLAY

Now you can see the pre-set module is recalled and loaded into A/B hardware modules

DESCRIPTION

OVERLAY

DESCRIPTION

OVERLAY

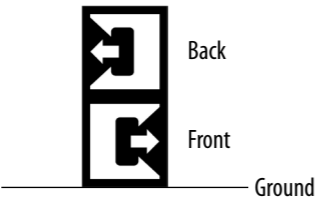
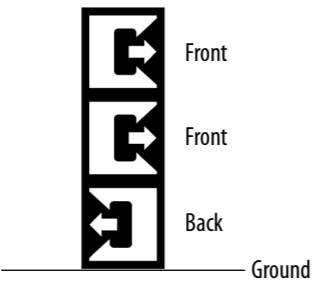
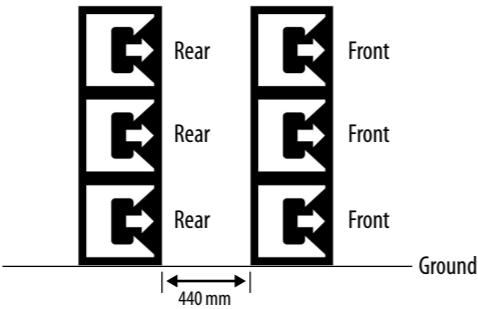
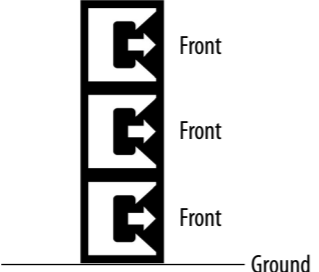
SUBWOOFER STRATEGY	ILLUSTRATION
<p>The Manchester series has a powerful yet simple Subwoofer pre-set strategy.</p> <p>Warning: Do not combine MS215, MS218, MS121 subwoofers on the same amplifier/DSP circuit.</p>	
<p>Cardioid BF</p> <p>1:1 ratio</p> <p>1 cabinet facing Front, 1 cabinet facing Back</p> <ul style="list-style-type: none"> • Effective cardioid patten • Good rear rejection • Some compromise of transience response • Less efficient use of subwoofers 	
<p>Cardioid BFF</p> <p>2:1 ratio</p> <p>2 cabinets facing Front, 1 cabinet facing Back</p> <ul style="list-style-type: none"> • Effective cardioid patten • Good rear rejection • Some compromise of transience response • The best ratio for efficient use 	
<p>Inverted End Fire</p> <p>1:1 ratio</p> <p>Front cabinets using FRONT preset</p> <p>Rear cabinets using REAR preset. Rear cabinets facing forward, at the rear in a 2 cell inverted end fire array</p> <ul style="list-style-type: none"> • Effective cardioid patten • Good rear rejection • Excellent transience response • Efficient use of subwoofers • More physical depth required (800 mm + 440 mm + 800mm) 	
<p>Traditional</p> <ul style="list-style-type: none"> • All cabinets facing Front • Effectively omni directional • Excellent transience response 	

Array Size Compensation (ASC) Overlays

Three ASC overlays are available, and it is recommended that ALL enclosures in the array have ASC selected.

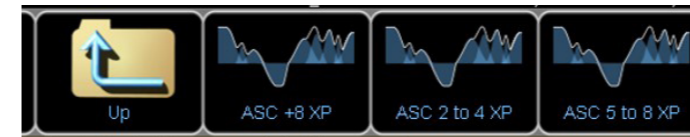

The 6 dB low-frequency shelving characteristic offsets LF/MF array coupling.

Note: Single MV210-HC do not normally require ASC overlay.

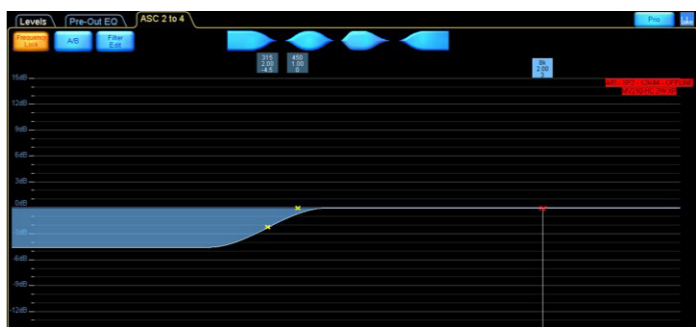
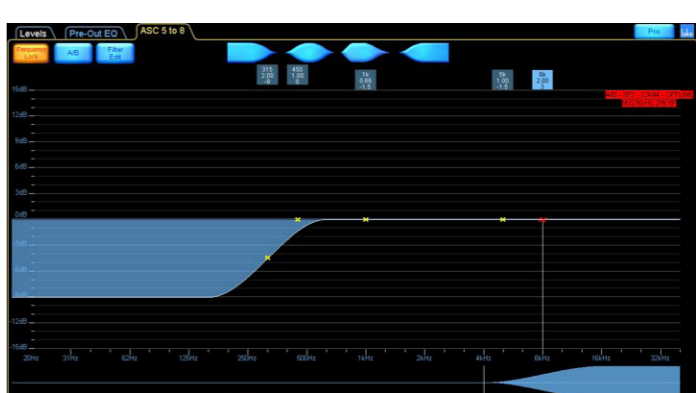
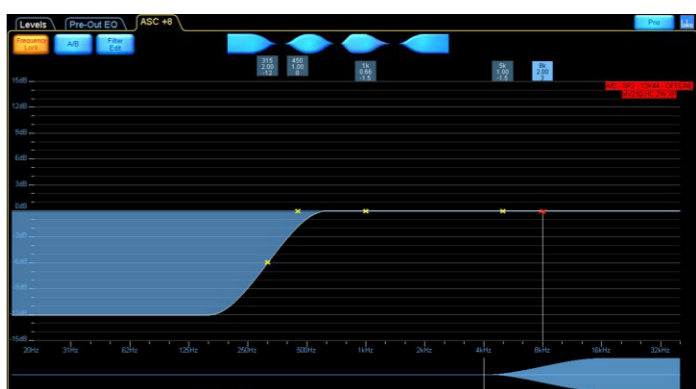
ASC OVERLAY DESCRIPTION	OVERLAY
<p>ASC 2 to 4: 2 to 4 cabinets</p>	
<p>ASC 5 to 8: 5 to 8 cabinets</p>	
<p>ASC +8: more than 8 cabinets</p>	

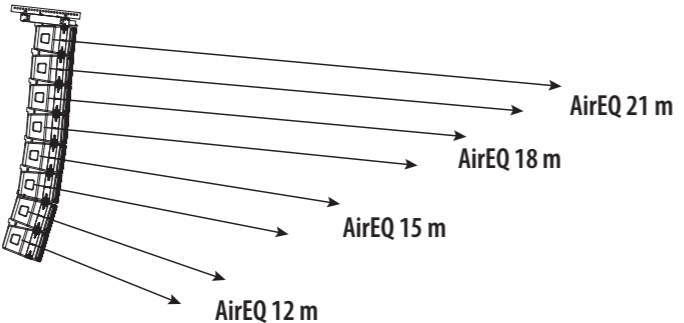
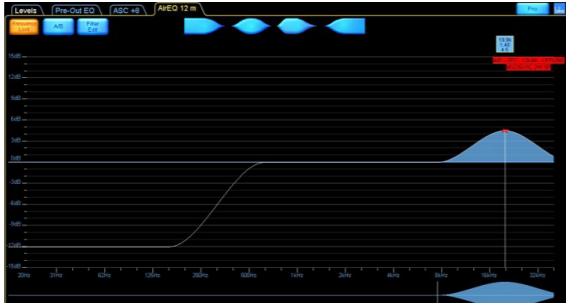
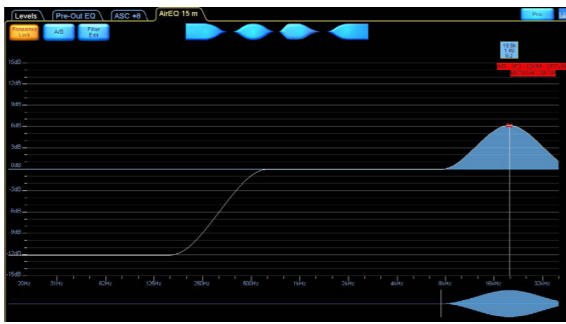
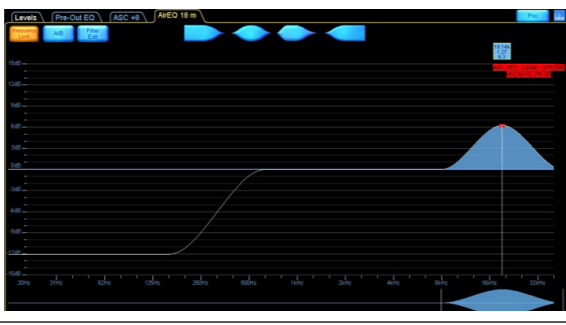
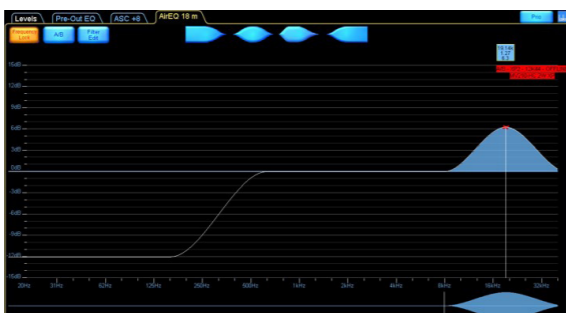
DISTANCE EQ COMPENSATION	OVERLAY
<p>All speakers are affected by air loss over distance; this set of overlays is in increments of 3 m, and ensures a balanced high frequency response over distance. Peaking or Bell filters are used to keep headroom in the high frequency band rather than high shelf filters which unnecessarily use up headroom for frequency which will not travel over far distances.</p> <p>Rules of AirEQ:</p> <p>DO NOT INSERT MORE THAN 1 FILTER AT THE SAME TIME.</p> <p>FOR INTERMEDIATE DISTANCES, USE THE CLOSEST OVERLAY AVAILABLE</p> <p>AirEQ overlays are available at: 9 m, 12 m, 15 m, 18 m, 21 m, 24 m, 27 m, 40 m, 50 m, and + 50 m</p> <p>Below are some examples of how the useful frequency and gain changes over distance:</p>	<p>Two elements per amplifier DSP module block</p> 
<p>AirEQ12 m – For elements within an array aimed at 12 m distance</p>	
<p>AirEQ15 m – For elements within an array aimed at 15 m distance</p>	
<p>AirEQ18 m – For elements within an array aimed at 18 m distance</p>	
<p>AirEQ21 m – For elements within an array aimed at 21m distance</p>	

EQ STRATEGY: Considerations for constant frequency response in the sound field

Flat arrays (minimum inter-element angle between elements) will have an increase in the mid frequency band typically between 630 Hz -2 kHz

Flat Array

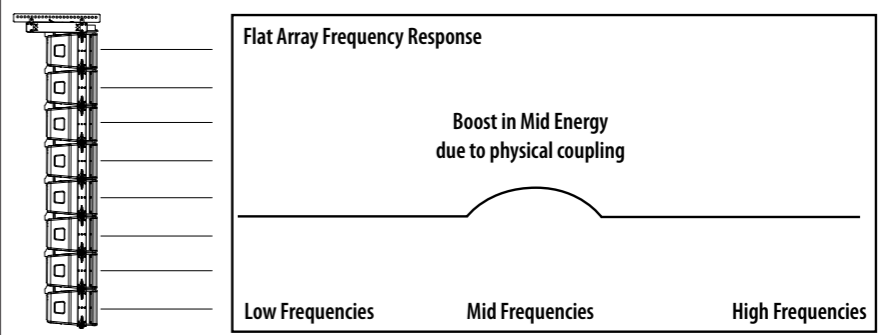

Curved array (inter-element angle used between elements) will have decrease in the mid frequency band typically between 630 Hz -2 kHz

Curved Array

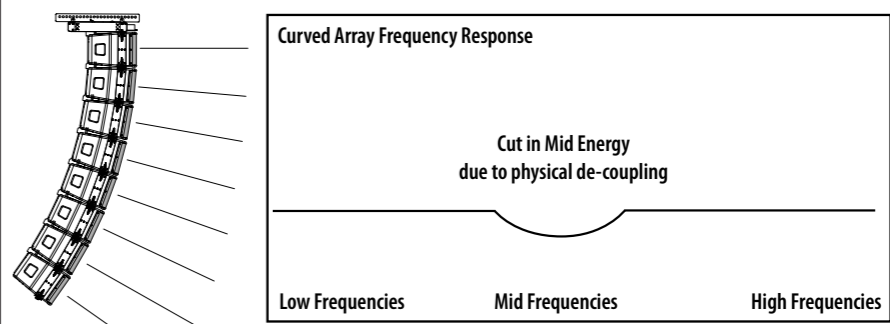

It is recommended that you split the EQ strategy to suit the mechanical curvature of the array, to gain constant frequency response.



Example: Here we have a typical J curved array of 8 MV210-HC elements – as we have 2 MV210-HC elements per Lake DSP module, it gives 4 discrete ZONES that can have small adjustments in the mid band area that is affected by the mechanical aiming of the array causing coupling and de-coupling.

Using one of the many industry-standard measurement software systems, reference microphones and sound-cards, find the mid range frequency affected, and adjust each zone for constant frequency response between zones / sound field area.

Lake software offers integration to many of these software systems, further information can be found at www.labgruppen.com

Curved Array

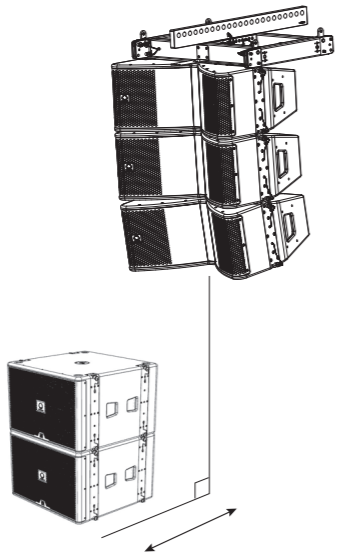

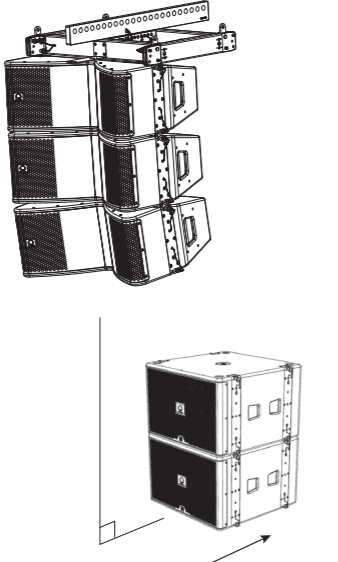
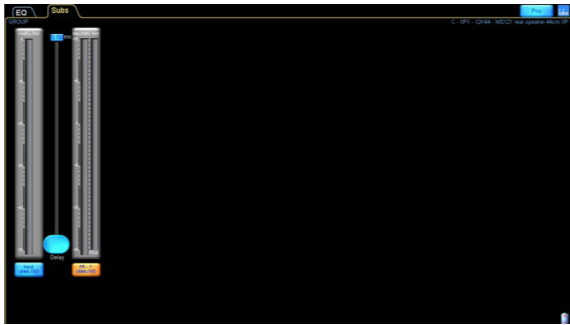
SUBWOOFER TIME ALIGNMENT	ILLUSTRATION	OVERLAY
<p>MS121 pre-sets use all-pass filters to set the initial time alignment (assuming the fronts of the cabinets are in line) this greatly reduces system latency.</p> <p>For example: If the fronts of the MV210-HC and MS121 are aligned, then in both pre-sets, the delay should be set to the default which is 0ms.</p> <p>However, in the real world it is not always possible to have your flown array and your ground stacked bass aligned in the vertical plane.</p> <p>1. In the picture to the right, the MS121 subs are 'forward' of the MV210-HC flown array. So the MS121 subs need to be delayed.</p>	<p>1. Subs are forward</p> 	
<p>2. In the picture to the right, the MV210-HC flown array is now 'forward' of the MS121 ground stacked subs. So the MV210-HC array needs to be delayed.</p> <p>So how do you find the correct delay time to align the flown array to the ground stacked bass?</p> <p>Some basic knowledge of delay units can get you an acceptable result by measuring the distance between the fronts of the flown array and the front of the ground stacked array. Remember within Lake software you can choose the delay unit; ms, m, or feet.</p> <p>1 ms (milliseconds) = 0.343 m (meters) = 1.125 ft (feet)</p> <p>Further fine-tuning can be done by using one of the many industry standard measurement software systems, reference microphones and sound-cards. Lake software offers integration to many of these software systems, and further information can be found at www.labgruppen.com</p>	<p>2. Flown array is forward</p> 	

Distance (time) is the difference to add to the flown array for alignment at the listening point

Specifications

	MV210-HC	MS121
System		
Frequency response (-3 dB) ¹	58 Hz - 20 kHz	25 Hz - 95 Hz
Frequency response (-10 dB) ¹	42 Hz - 20 kHz	20 Hz - 200 Hz
Nominal dispersion	100 degrees (H) x 20 degrees (V)	Omni
Power handling (IEC)	LF: 800 W continuous	2000 W continuous
	MHF: 190 W continuous	—
Sensitivity	LF: 102 dB (1 W @ 1 m) ²	97 dB (1 W @ 1 m) ²
	MHF: 114.5 dB (1 W @ 1 m) ²	—
Maximum SPL	144 dB ³	142 dB ⁴
	LF: 8 Ω	8 Ω
Impedance	MHF: 12 Ω	—
	Crossover type	External bi-amp
Components	2 x 10" (250 mm) LF driver	1 x 21" (530 mm) LF driver
	1 x 1.4" (35 mm) exit, large format dual compression driver	—
IP Rating	54	54
UV Rating	4-5	4-5
Enclosure		
Connectors	2 x speakON NLT4MP STX	3 x speakON NLT4MP STX
Wiring	Pins 1+ / 1- LF, pins 2+ / 2- MHF	Pins 1+ / 1- LF, pins 2+ / 2- LINK (Front Pins 2+ / 2- only)
Dimensions H x W x D	295 x 715 x 545 mm (11.6 x 28.1 x 21.5")	599 x 777 x 800 mm (23.6 x 30.6 x 31.5")
Net weight	35.5 kg (78.3 lbs)	87.4 kg (192.7 lbs)
Construction	15 mm (enclosure) and 18 mm (front) marine birch plywood, vented and internally braced	Mix 21 mm and 18 mm marine birch plywood, vented and internally braced
Finish	Polyurethane black, with custom colours on request	Polyurethane black, with custom colours on request
Grille	Powder coated perforated steel	Powder coated perforated steel
Flying hardware	3 point rigging system	4 point rigging system
Accessories		
Fly Grid	MAN210-FG fly grid	MAN210-FG fly grid
Vertical Transporter	MV210-VT	MS121-VT

- Notes
1. Average over stated bandwidth. Measured at 1 metre on axis.
 2. SPL level at 1 m under free field conditions, using pink noise with crest factor 4, with dedicated pre-set.
 3. Average Peak level over overlap bandwidth. Measured at 1 metre on axis with dedicated pre-set.
 4. Peak level at 1 m under half space conditions using pink noise with crest factor 4, with dedicated pre-set. Ease Data can be downloaded from www.turbosound.com

Other important information

EN Important information

1. Register online. Please register your new Music Tribe equipment right after you purchase it by visiting musictribe.com. Registering your purchase using our simple online form helps us to process your repair claims more quickly and efficiently. Also, read the terms and conditions of our warranty, if applicable.

2. Malfunction. Should your Music Tribe Authorized Reseller not be located in your vicinity, you may contact the Music Tribe Authorized Fulfiller for your country listed under "Support" at musictribe.com. Should your country not be listed, please check if your problem can be dealt with by our "Online Support" which may also be found under "Support" at musictribe.com. Alternatively, please submit an online warranty claim at musictribe.com BEFORE returning the product.

3. Power Connections. Before plugging the unit into a power socket, please make sure you are using the correct mains voltage for your particular model. Faulty fuses must be replaced with fuses of the same type and rating without exception.



Hereby, Music Tribe declares that this product is in compliance with Directive 2011/65/EU and Amendment 2015/863/EU, Directive 2012/19/EU, Regulation 519/2012 REACH SVHC and Directive 1907/2006/EC, and this passive product is not applicable to EMC Directive 2014/30/EU, LV Directive 2014/35/EU.

Full text of EU DoC is available at <https://community.musictribe.com/>

EU Representative: Music Tribe Brands DK A/S
Address: Gammel Strand 44, DK-1202 København K, Denmark

UK Representative: Music Tribe Brands UK Ltd.
Address: 6 Lloyds Avenue, Unit 4CL London EC3N 3AX, United Kingdom

