

Small Format Mixers

XENYX X2442USB / X2222USB X1832USB / X1622USB X1222USB / X1204USB / 1204USB



XENYX—Premium Mixer with XENYX Mic Preamps & Compressors, British EQs, 24-Bit Multi-FX Processor and USB/Audio Interface

- Premium ultra-low noise, high headroom analog mixer
- State-of-the-art XENYX Mic Preamps comparable to stand-alone boutique preamps
- Studio-grade compressors with super-easy “one-knob” functionality on all mono channels
- Neo-classic “British” 3-band EQs for warm and musical sound
- New studio-grade FX processor with 16 editable presets including reverb, chorus, flanger, delay, pitch shifter, multi-effects, Tap function and storable user parameter settings (not available on 1204USB)
- Built-in stereo USB/Audio Interface to connect directly to your computer. Free audio recording, editing and podcasting software plus 150 instrument/effect plug-ins and ultra-low latency driver included
- Stereo graphic EQ allows precise frequency correction of monitor or main mixes with revolutionary FBQ Feedback Detection System (X1222USB and X1832USB only)
- Breathtaking XPQ 3D stereo surround effect for more vitality and enhanced stereo image and Voice Canceller function for easy-to-use sing-along applications (X1222USB and X1832USB only)

You’ve got the talent. You’re brimming with creativity. And you’re ready to get your message out to the masses. But is “old-school” technology standing in the way of your success? Can’t afford professional recording time?

XENYX USB Series mixers are designed to handle your live gigs, and they provide the state-of-the-art tools you need to make stunning, professional-quality recordings.

Along with their built-in USB/audio interfaces, XENYX USB mixers come with all the recording and editing software you’ll need to turn your computer system into a complete, high-performance home recording studio.

Sonically Superior Mic Preamps

All XENYX mixers have one thing in common—great-sounding, high headroom XENYX mic preamps. These state-of-the-art mic pres represent a major step in the evolution of audio technology—and they can easily hold

their own, even when compared to the most expensive stand-alone mic preamps. XENYX preamps offer a staggering 130 dB of dynamic range, with a bandwidth that extends from below 10 Hz to well above 200 kHz. Armed with these outstanding mic preamps, XENYX mixers provide such transparent, crystal-clear performance you just might think someone upgraded your mics while you weren’t looking.

Sublimely Musical British EQ

The British consoles of the 1960s and ‘70s changed the sound of rock and roll—without them the British Invasion might not have happened. Those legendary mixing desks soon became the envy of engineers and producers all over the world. The channel EQ on our XENYX mixers is based on that very same circuitry, allowing you to imbue signals with incredible warmth and detailed musical character. Even when applied generously, these equalizers exhibit sweet forgiveness and superb audio quality.

Continued on next page



XENYX X2442USB X2222USB / X1832USB X1622USB / X1222USB X1204USB / 1204USB

- Channel inserts on each mono channel for flexible connection of outboard equipment (not available on 1204USB or X1204USB)
- 2-4 aux sends per channel (see table for details)
- Clip LEDs on all channels, mute/alt 3-4 function on 1204USB or X1204USB models
- 2 subgroups on X1622USB, X1832USB and X2222USB (4 subgroups on X2442USB) with separate outputs for added routing flexibility
- 2-4 multi-functional stereo aux returns for flexible routing (see table for specific model details)
- Balanced main mix outputs with gold-plated XLR connectors
- Control room/phones outputs with multi-input source matrix
- Long-wearing 60-mm logarithmic-taper faders and sealed rotary controls
- "Planet Earth" switching power supply for maximum flexibility (100 - 240 V~), noise-free audio, superior transient response plus low power consumption for energy saving
- Rack mount brackets included for ultimate flexibility

behringer.com

One-knob Compression

Ask professional sound engineers what their favorite piece of external processing gear is and the majority response will be virtually unanimous—dynamic compression. What is compression? We're glad you asked. Compression essentially limits the dynamic range of a signal, lowering the level of loud sounds and turning up softer sounds, to achieve sonic balance.

But applying compression is a delicate art that many novice, and even intermediate, sound techs have great difficulty mastering. Our "one-knob" compression is available on all mono channels and is easy to operate, even for entry-level users. With this one knob, you can easily dial in the perfect amount of compression for instruments and vocals, creating powerful mixes with punch and clarity. This is indeed a rare feature for products in this class—but standard on all XENYX USB mixers.

Effective FX

All XENYX USB Series mixers (except the 1204USB) feature our new 24-bit dual engine FX processor, with 16 editable, studio-grade presets including reverb, chorus, flanger, delay, pitch shifter and multi-effects. Complete with a highly accurate input meter, these effects can be altered to your personal taste via the Parameter control. Time-based functions can be entered manually by pressing the Tap button in tempo with the music.

Recording Bliss

There was a time when the recording process called for lots and lots of expensive gear, which meant the average musician had to buy time at a recording studio—and that time was pricey indeed. But modern technology has put personal recording well within the reach of virtually anyone with access to a computer. How do you get all that music flying around your brain into your computer? That's where XENYX USB mixers come in. Thanks to the built-in, bi-directional stereo USB audio interface, you can connect any of these mixers directly to your PC or Mac computer via a single USB cable. Now any signal source you connect to the mixer can be recorded directly to your hard drive. Which brings us to software...

Free Would Be Nice!

Because you'll want to take full advantage of the XENYX USB Series mixers' recording and podcasting potential, we've thrown in a massive software package that includes Audacity (the most popular open source audio editor), Podifier, Juice, Podnova and Golden Ear (a great selection of podcasting software). You're ready to go live on your PC or Mac computer right out of the box! You also get more than 100 virtual instruments and 50 FX plug-ins, turning your computer into a complete home-based or mobile recording studio from input to output.



XENYX X2442USB X2222USB / X1832USB X1622USB / X1222USB X1204USB / 1204USB



	1204USB	X1204USB	X1222USB	X1622USB	X1832USB	X2222USB	X2442USB
Mic Preamps	4	4	6	4	6	8	10
Stereo Channels	2	2	4	4	4	4	4
Aux Sends	2	2	2	2	3	3	4
Stereo Aux Returns	2	2	2	2	2	3	4
Phantom Power	✓	✓	✓	✓	✓	✓	✓
Channel Inserts	—	—	4	4	6	8	8
Mono Channel EQ	3-band	3-band	3-band	3-band semi-parametric mid	3-band semi-parametric mid	3-band semi-parametric mid	3-band semi-parametric mid
Compressors	4	4	4	4	6	8	10
Stereo Channel EQ	3-band	3-band	3-band	4-band fixed	4-band fixed	4-band fixed	4-band fixed
Stereo Graphic EQ	—	—	7-band	—	9-band	—	—
FBQ	—	—	✓	—	✓	—	—
XPQ 3D	—	—	✓	—	✓	—	—
Voice Canceller	—	—	✓	—	✓	—	—
FX Processor	—	✓	✓	✓	✓	✓	✓
Built-in USB Audio Interface	✓	✓	✓	✓	✓	✓	✓
Mute/Alt 3-4	✓	✓	—	—	—	—	—
Subgroups	—	—	—	2	2	2	4
Software Bundle	✓	✓	✓	✓	✓	✓	✓
Dimensions (H x W x D)	3.8 x 9.72 x 3.15" 97 x 247 x 334 mm	3.8 x 9.72 x 3.15" 97 x 247 x 34 mm	3.54 x 14.57 x 13" 90 x 370 x 330 mm	3.54 x 12.60 x 13.39" 90 x 320 x 340 mm	3.54 x 16.93 x 14" 90 x 430 x 355 mm	3.54 x 16.93 x 14" 90 x 430 x 355 mm	5.31 x 17.32 x 16.54" 135 x 440 x 420 mm
Weight	5.75 lbs / 2.6 kg	5.75 lbs / 2.6 kg	8.16 lbs / 3.7 kg	7.60 lbs / 3.45 kg	10.22 lbs / 4.64 kg	10.5 lbs / 4.78 kg	13 lbs / 5.92 kg
Rack Mount Brackets	✓	✓	✓	✓	✓	✓	✓

XENYX X2442USB X2222USB / X1832USB X1622USB / X1222USB X1204USB / 1204USB

Multi-FX Processor Preset Chart

No.	Effect	PROGRAM	Min. value	Max. value	Default	TAP	Min. value	Max. value	Default	TAP LED
Reverb										
01	HALL	Reverb time	01 (approx. 1.0 sec.)	10 (approx. 8.0 sec.)	03	Brilliance	oF	on	on	off/on lighting
02	ROOM	Reverb time	01 (approx. 0.5 sec.)	10 (approx. 4.0 sec.)	04	Brilliance	oF	on	oF	off/on lighting
03	PLATE	Reverb time	01 (approx. 0.5 sec.)	10 (approx. 5.0 sec.)	03	Brilliance	oF	on	on	off/on lighting
04	GATED	Reverb time	01 (approx. 0.1 sec.)	10 (approx. 1.0 sec.)	02	Brilliance	oF	on	oF	off/on lighting
05	REVERSE	Reverb time	01 (approx. 0.1 sec.)	10 (approx. 1.0 sec.)	05	Brilliance	oF	on	oF	off/on lighting
Ambience / Delay										
06	EARLY REFLECTIONS	Room size	01 (small)	10 (extra large)	05	Brilliance	oF	on	oF	off/on lighting
07	AMBIENCE	Area size	01 (small)	10 (extra large)	05	Brilliance	oF	on	on	off/on lighting
08	DELAY	No. of repetitions	01 (min. feedback)	20 (max. feedback)	04	Time Interval (BPM)	07 (72 BPM)	60 (600 BPM)	12 (120 BPM)	blinks BPM Tempo
09	ECHO	No. of repetitions	01 (min. feedback)	40 (max. feedback)	20	Time Interval (BPM)	07 (72 BPM)	60 (600 BPM)	10 (100 BPM)	blinks BPM Tempo
Modulation										
10	CHORUS	Intensity (Depth)	01 (1 %)	99 (99 %)	30	Tempo (LFO-Speed)	02 (24 BPM)	48 (480 BPM)	06 (60 BPM)	blinks mod speed
11	FLANGER	Intensity (Depth)	01 (1 %)	99 (99 %)	40	Tempo (LFO-Speed)	02 (24 BPM)	48 (480 BPM)	09 (90 BPM)	blinks mod speed
12	PHASER	Intensity (Depth)	01 (1 %)	99 (99 %)	60	Tempo (LFO-Speed)	02 (24 BPM)	48 (480 BPM)	03 (30 BPM)	blinks mod speed
Detune / Pitch										
13	DETUNE	Detune-Spreading	01 (1 cent)	99 (99 cent)	25	2nd voice delay	05 (short, 5 ms)	50 (long, 50 ms)	05 (5 ms)	off/on lighting
14	PITCH SHIFT	Semitone Steps	-12 (1 octave down)	12 (1 octave up)	03 (Minor 3rd)	Detune	oF (0 Cent)	on (+25 cent)	oF (0 Cent)	off/on lighting
Combination FX										
15	DELAY + REV	Ratio	-9 (90% DLY, 10% REV)	9 (10% DLY, 90% REV)	0 (50% / 50%)	DLY Time (BPM)	11 (116 BPM)	60 (600 BPM)	12 (120 BPM)	blinks BPM Tempo
16	CHORUS + REV	Ratio	-9 (90% CH, 10% REV)	9 (10% CH, 90% REV)	0 (50% / 50%)	Reverb time	12 (short, 1.2 s)	24 (long, 2.4 s)	12 (short, 1.2 s)	off/on lighting

XENYX X2442USB X2222USB / X1832USB X1622USB / X1222USB X1204USB / 1204USB

1204USB

Perfect for a small live-performance mixer, as well as home-based recording setup, the 1204USB provides four mono channels with premium XENYX mic preamps, neo-classic 3-band British-style EQ and two stereo input channels. Far from being a “bare-bones” mixer,

all mono channels feature our “one knob” studio-grade compressor and two Aux Sends (one each pre- and post-fader). Two stereo Aux Returns are included for use with external FX modules. The built-in USB audio interface provides bi-directional transfer of signals between the mixer and computer.

1204USB/X1204USB Front Panel

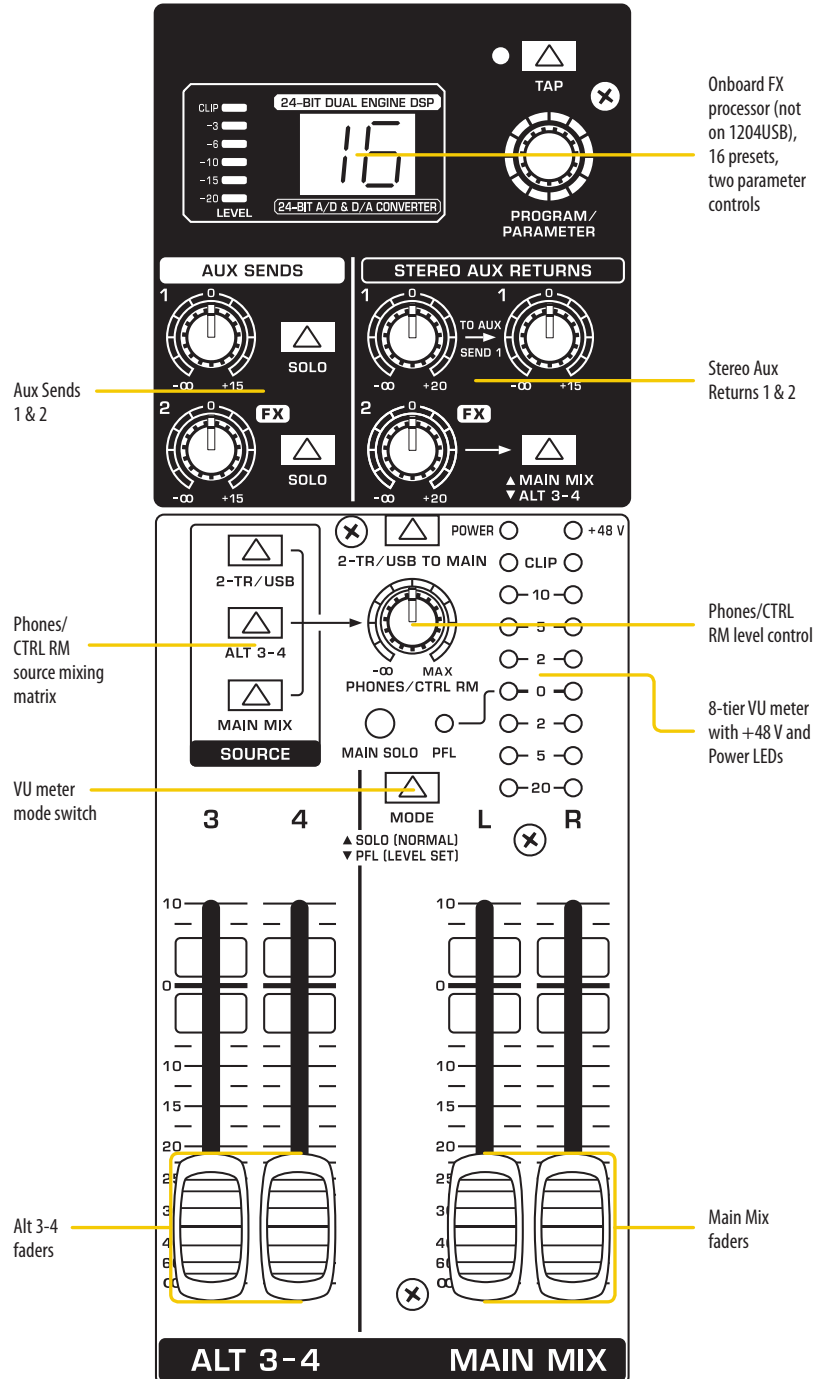
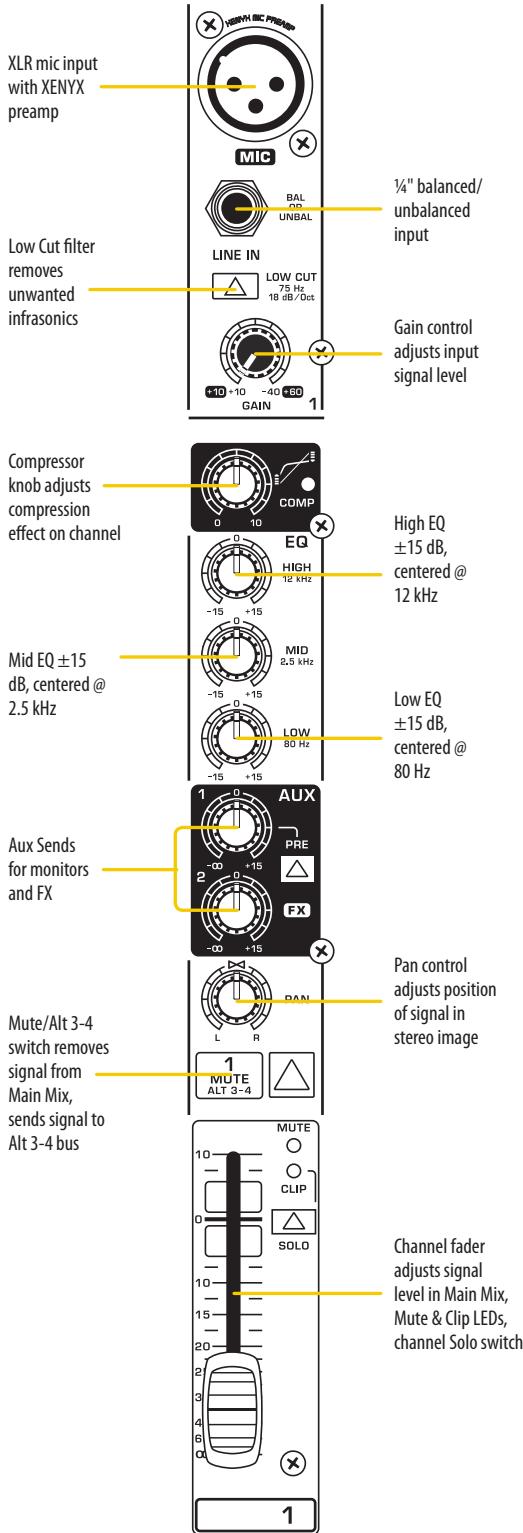

XENYX X2442USB X2222USB / X1832USB X1622USB / X1222USB X1204USB / 1204USB

X1204USB

The compact X1204USB mixer takes the 1204USB up a notch, providing all the same great features, plus our new 24-bit, dual engine FX processor, with 16 editable, studio-grade presets including reverb, chorus, flanger,

delay, pitch shifter and multi-effects. User-definable parameters include reverb time and brilliance, delay room size and repetitions, modulation depth and speed, and much more. Time-based functions can be addressed via a handy Tap button. The most recent parameter settings are always stored in memory.

X1204USB/1204USB Rear Panel

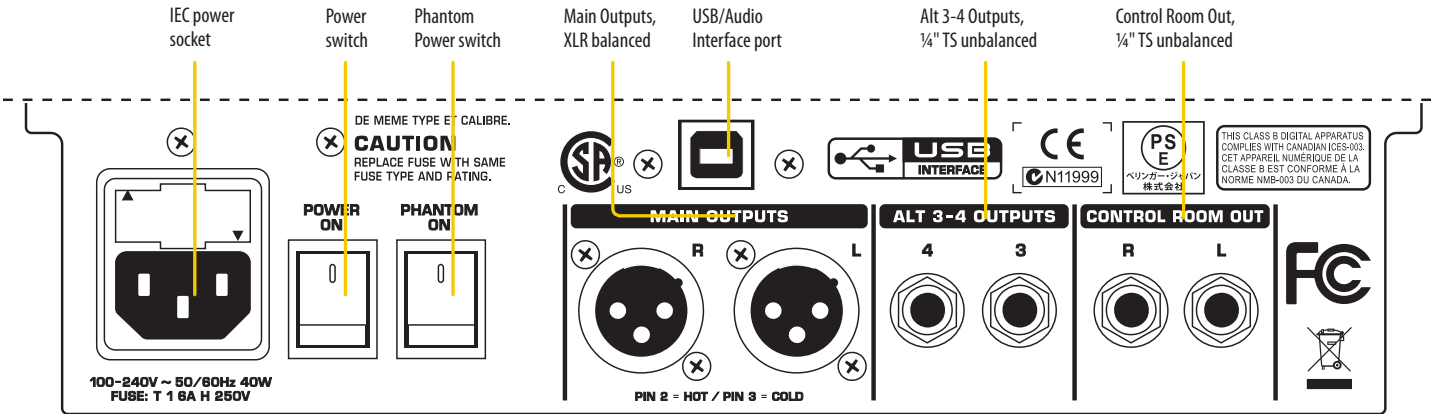

XENYX 1204USB Live/Recording Setup

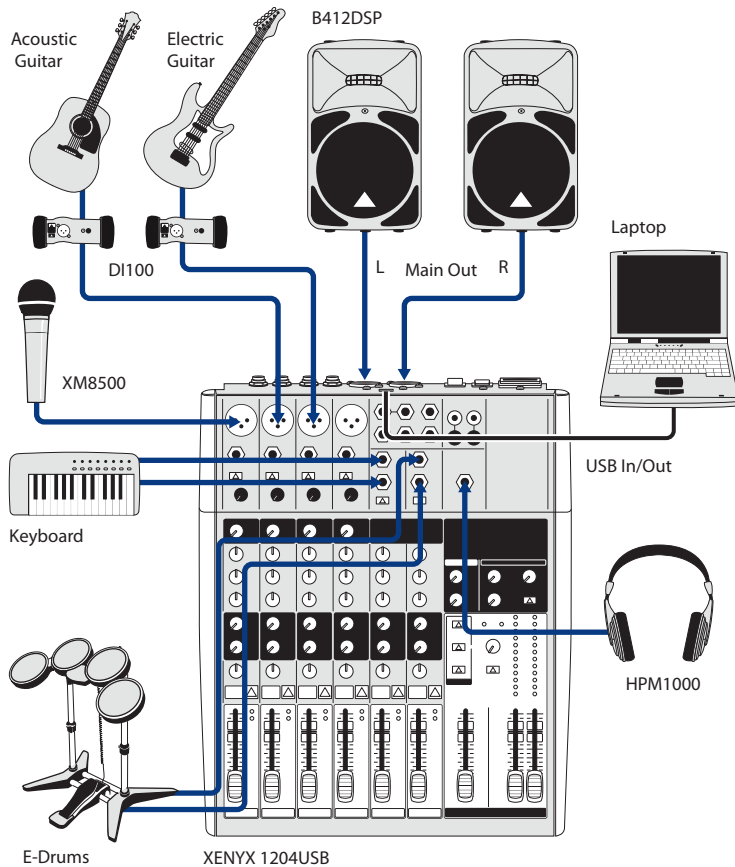

XENYX X1204USB Recording Setup

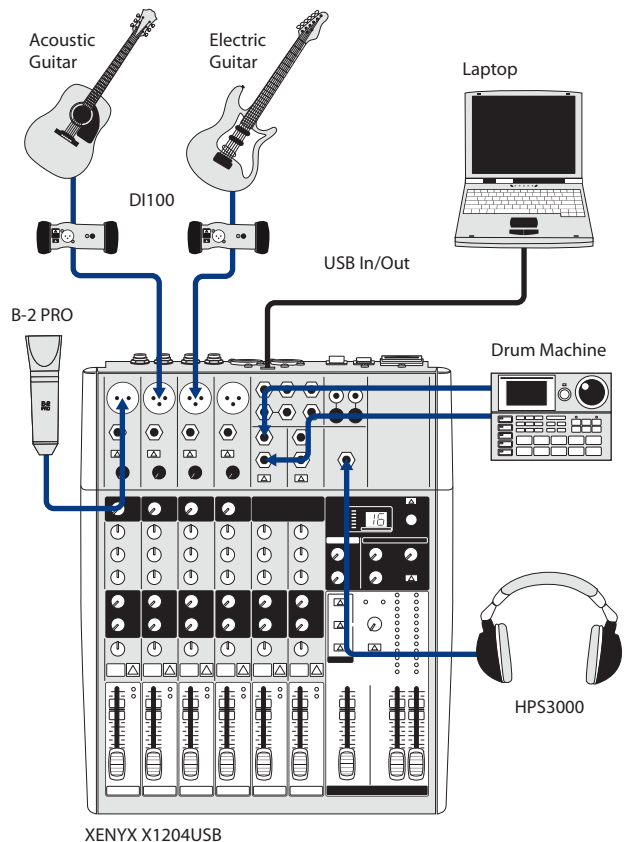

XENYX X2442USB X2222USB / X1832USB X1622USB / X1222USB X1204USB / 1204USB

X1222USB

The X1222USB ups the ante with six mono mic inputs. These two additional channels can also be used for stereo line-level devices, such as keyboards or sound modules. Building on the feature set of the two previous models, the X1222USB comes equipped with channel Inserts for inputs 1-4, a stereo 7-band

graphic EQ, which can be assigned to the main or monitor buses, and our proprietary FBQ Feedback Detection System. Other features include full-sized faders for MON and FX SENDs, our XPQ 3D stereo surround effect (creates a broader, enhanced stereo image), and a handy Voice Canceller function for removing vocals from pre-recorded tapes and CDs for "instant-karaoke" applications.

X1222USB Front Panel

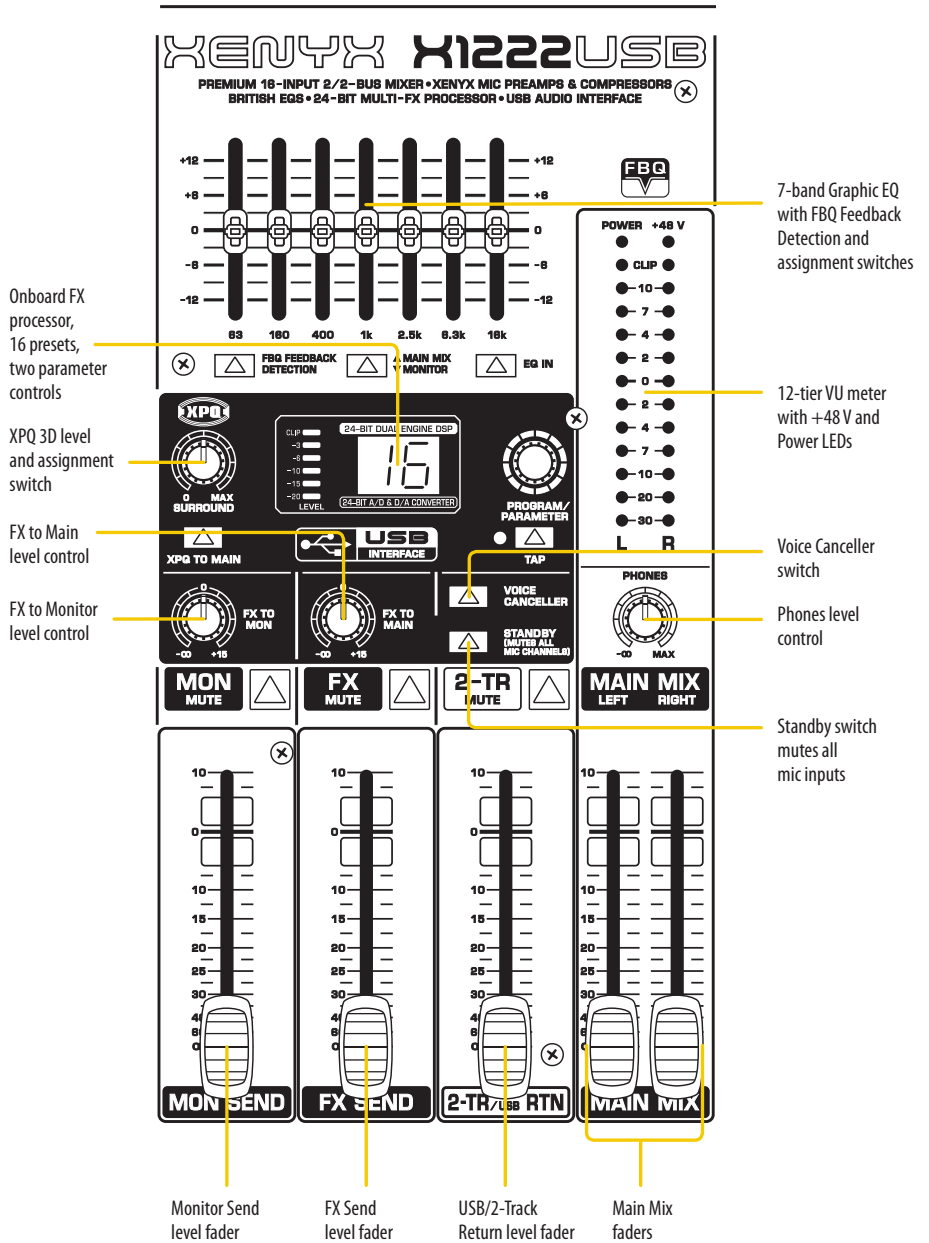
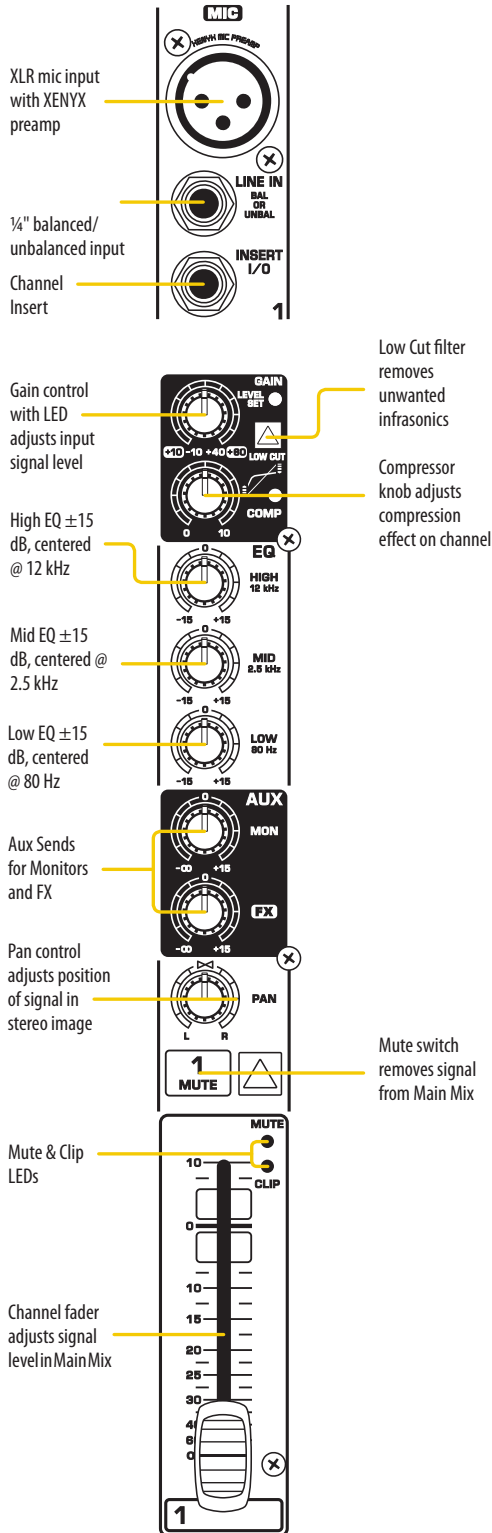

**XENYX X2442USB
X2222USB / X1832USB
X1622USB / X1222USB
X1204USB / 1204USB**

XENYX X1222USB Live/Recording Setup

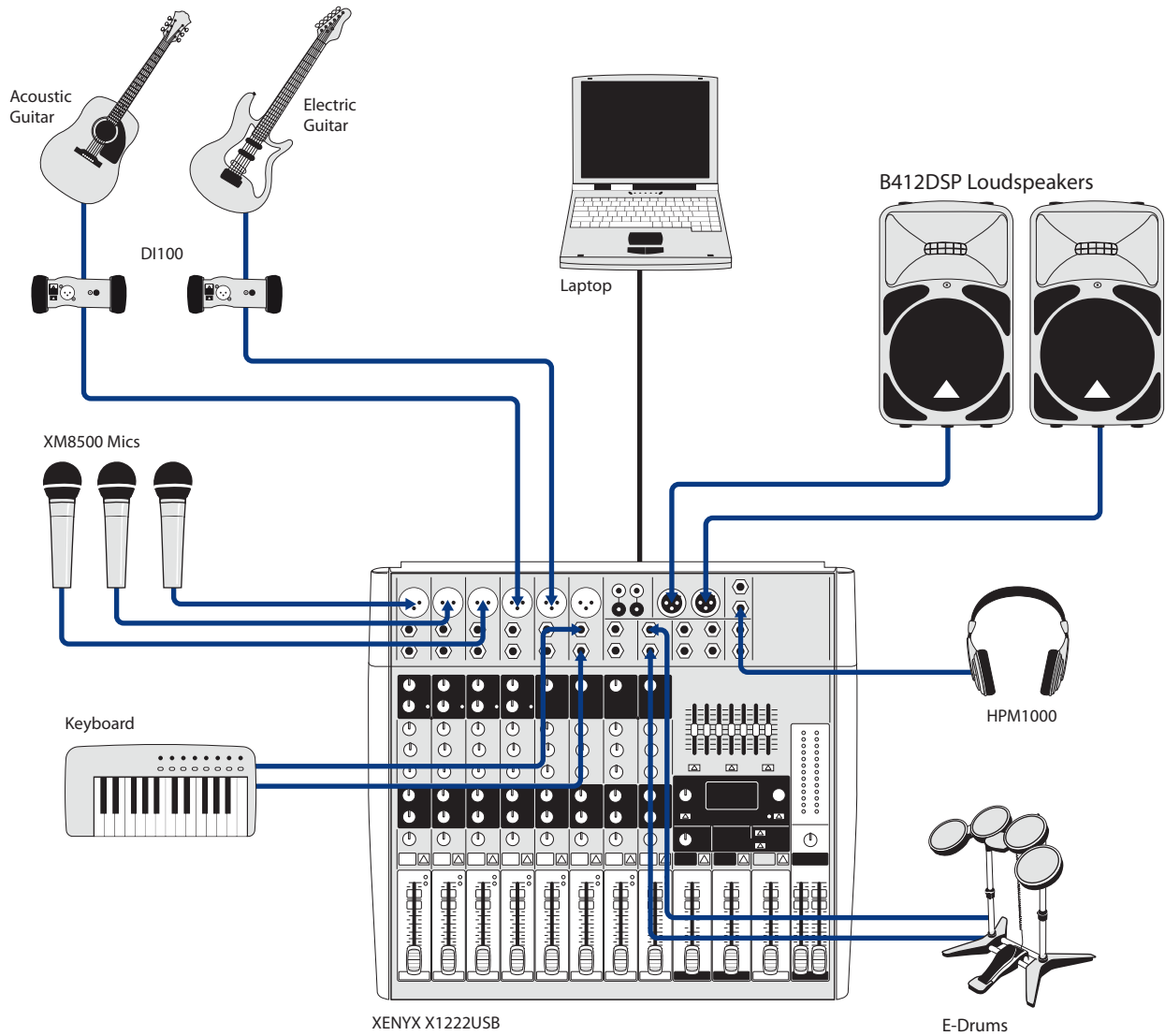

XENYX X2442USB X2222USB / X1832USB X1622USB / X1222USB X1204USB / 1204USB

X1622USB

The X1622USB features four XENYX-fueled mic inputs with channel Inserts, "one knob" compressors and 3-band British-style EQs with a sweepable, semi-parametric mid frequency band. The four stereo line-level channels offer

enhanced fine-tuning via 4-band EQ, which is extremely handy for adjusting critical keyboard midrange frequencies. Aux 1 Sends are switchable (pre- or post-fader) and individual channels can be assigned to two subgroups for mixing flexibility.

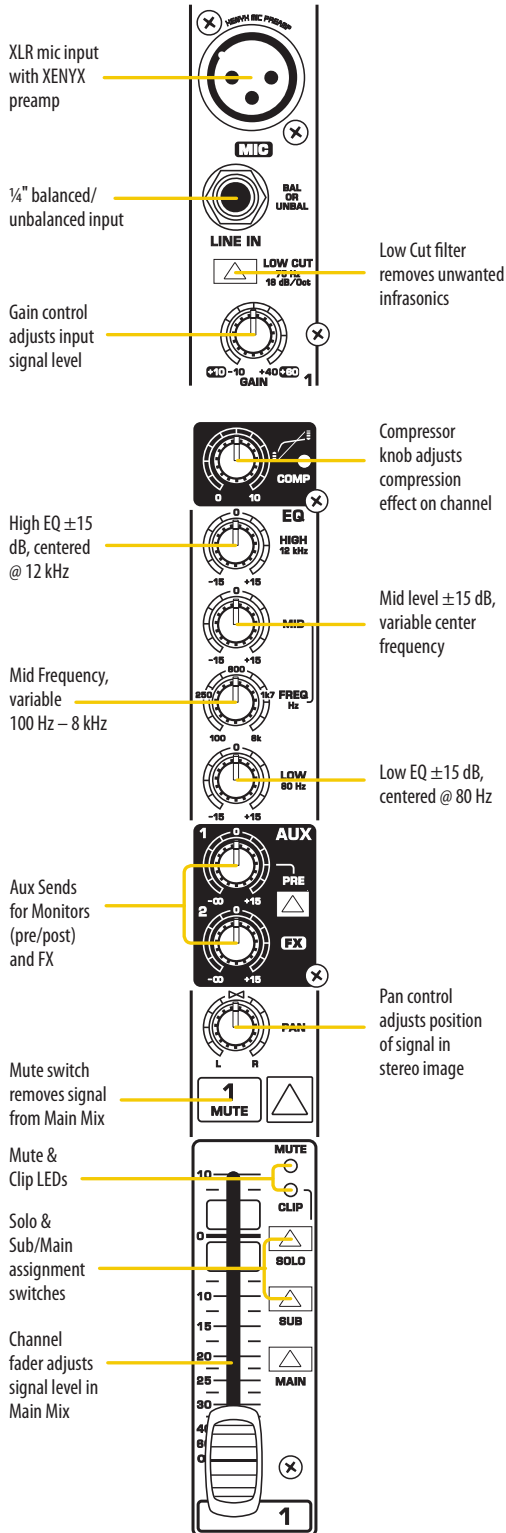

X1622USB Front Panel

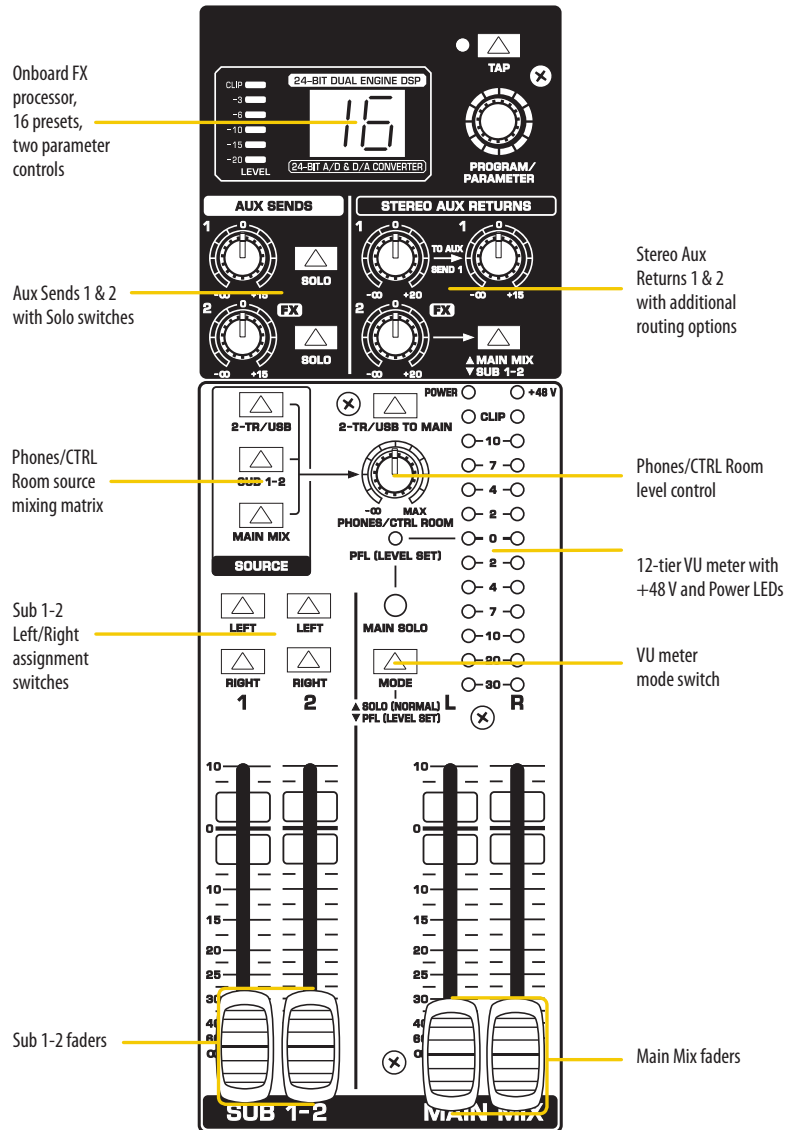

XENYX X2442USB X2222USB / X1832USB X1622USB / X1222USB X1204USB / 1204USB

X1622USB Rear Panel

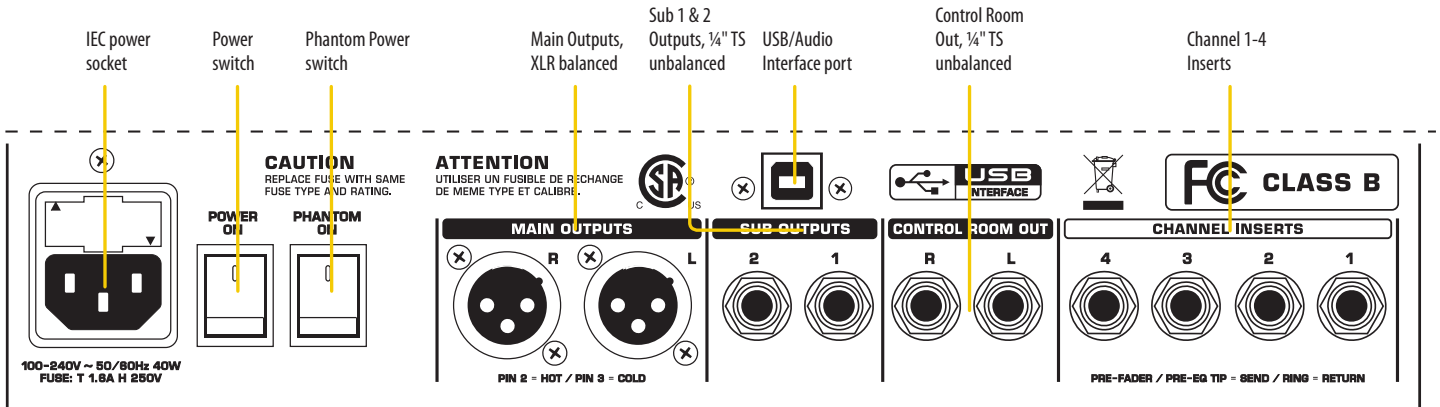

XENYX X1622USB Recording Setup

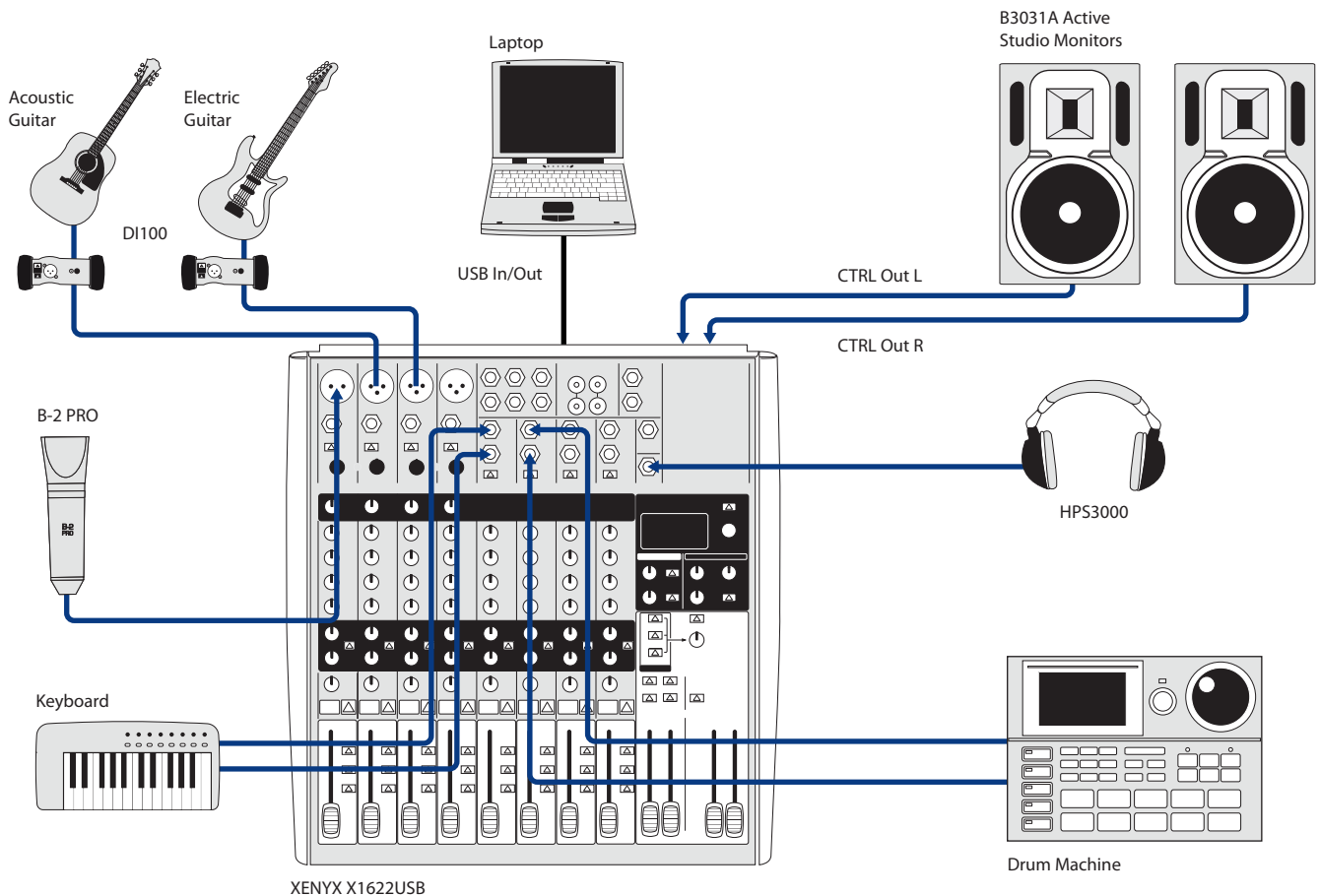

XENYX X2442USB X2222USB / X1832USB X1622USB / X1222USB X1204USB / 1204USB

X1832USB

Building on the feature set of the X1622USB, the X1832USB comes with two additional mic strips (including channel inserts), for a total of six XENYX mic preamps. The onboard stereo 9-band graphic equalizer, which can be assigned to the main or monitor buses, provides superb system EQ and works

in conjunction with the FBQ feedback detection circuitry to eliminate annoying mic squeals. Other features include full-sized faders for MON and FX SENDS, along with our proprietary XPQ 3D stereo surround effect and Voice Cancellor. The ultra-versatile X1832USB also has an additional Aux Send (switchable pre/post), for a total of three, and two assignable subgroups.

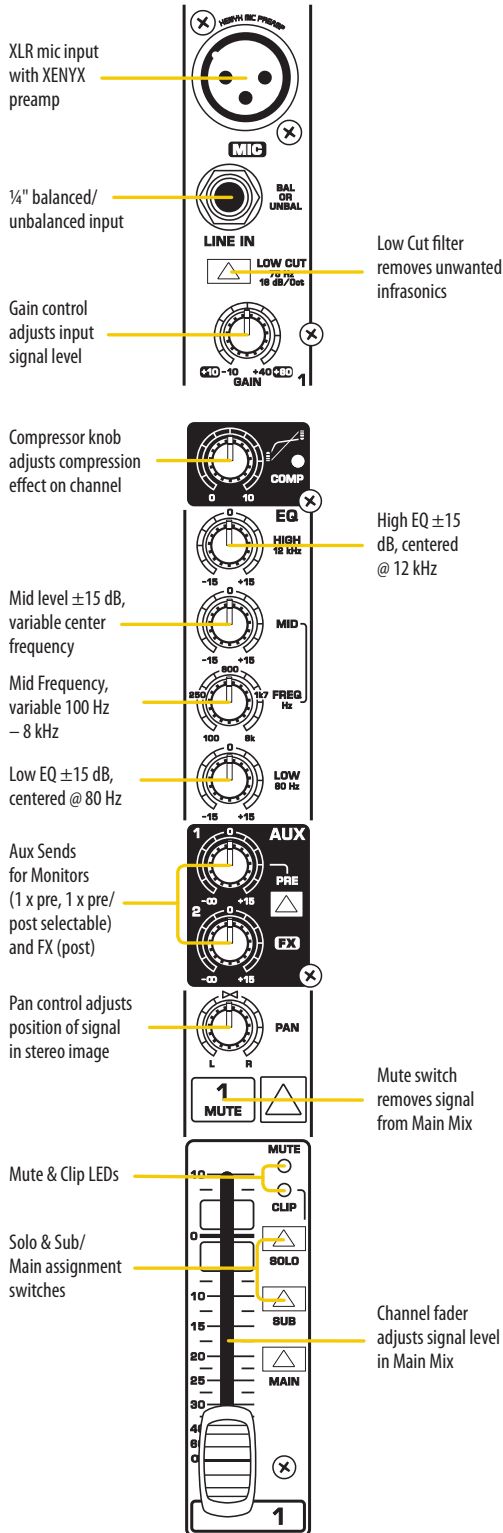

X1832USB Front Panel

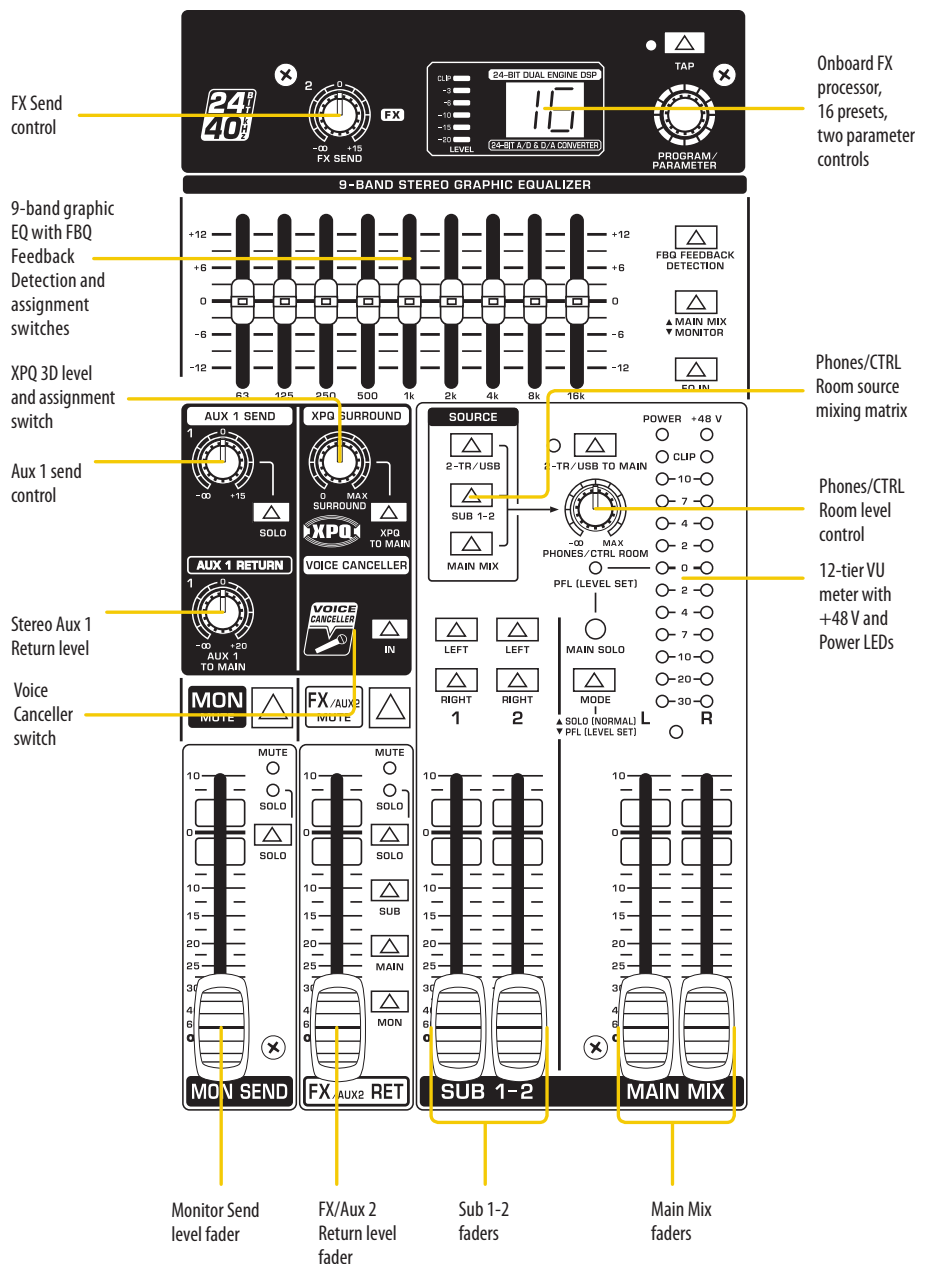

XENYX X2442USB X2222USB / X1832USB X1622USB / X1222USB X1204USB / 1204USB

X1832USB Rear Panel

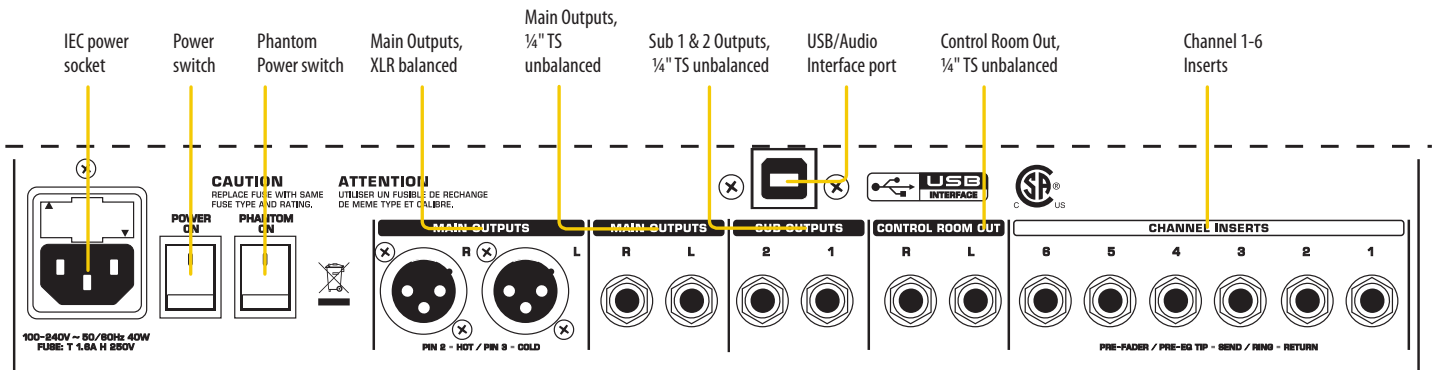

XENYX X1832USB Live/Recording Setup

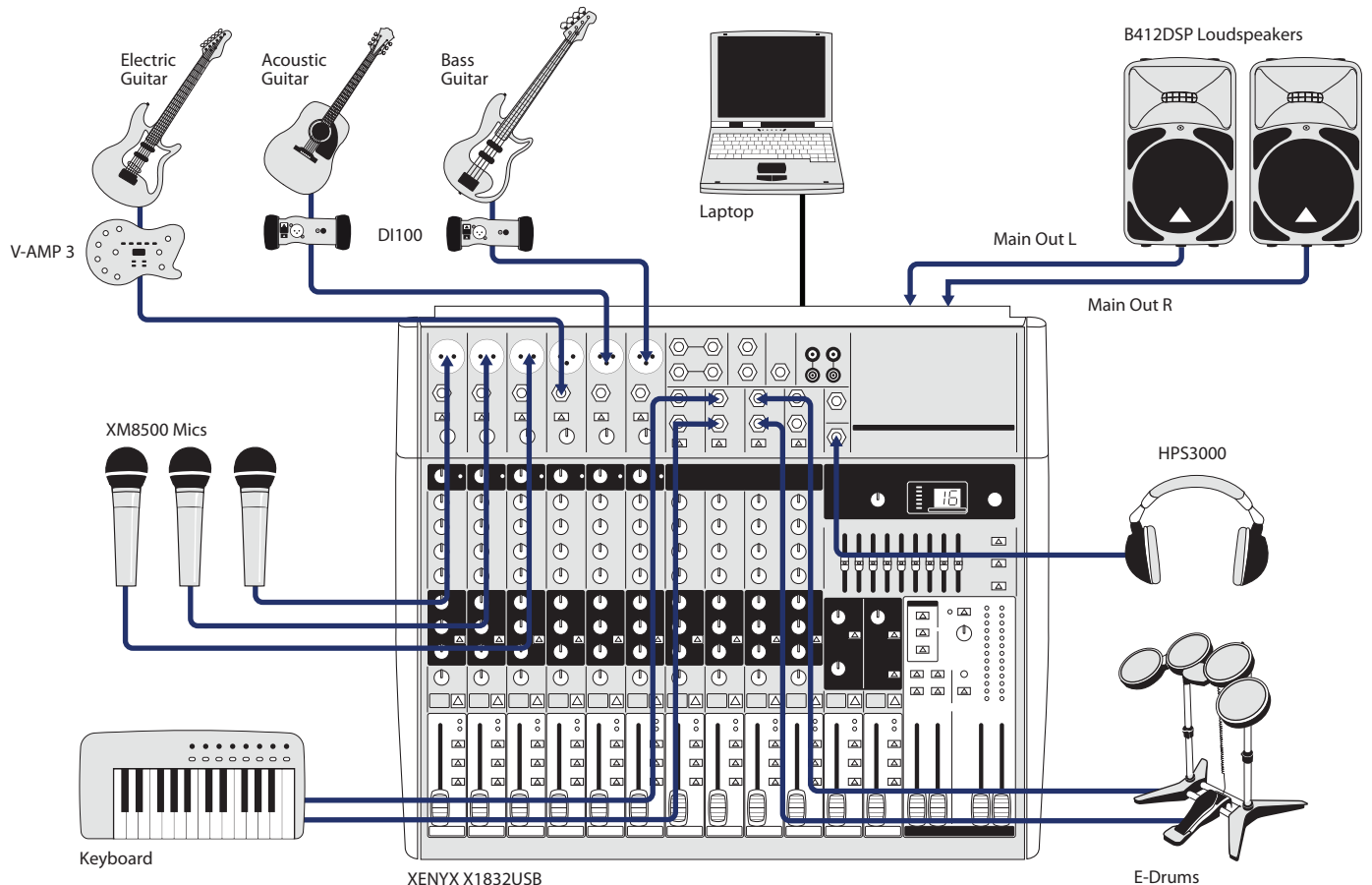

XENYX X2442USB X2222USB / X1832USB X1622USB / X1222USB X1204USB / 1204USB

X2222USB

How about eight XENYX mic channels with inserts, dedicated compressors, 3-band EQ with semi-parametric mids and three Aux Sends? You get all that with

the X2222USB, plus four stereo line-level channels, two convenient mix subgroups and onboard 24-bit digital FX processing, with dual user-addressable parameter controls. All this and more enclosed in a rack-ready, roadworthy steel chassis.

X2222USB Front Panel

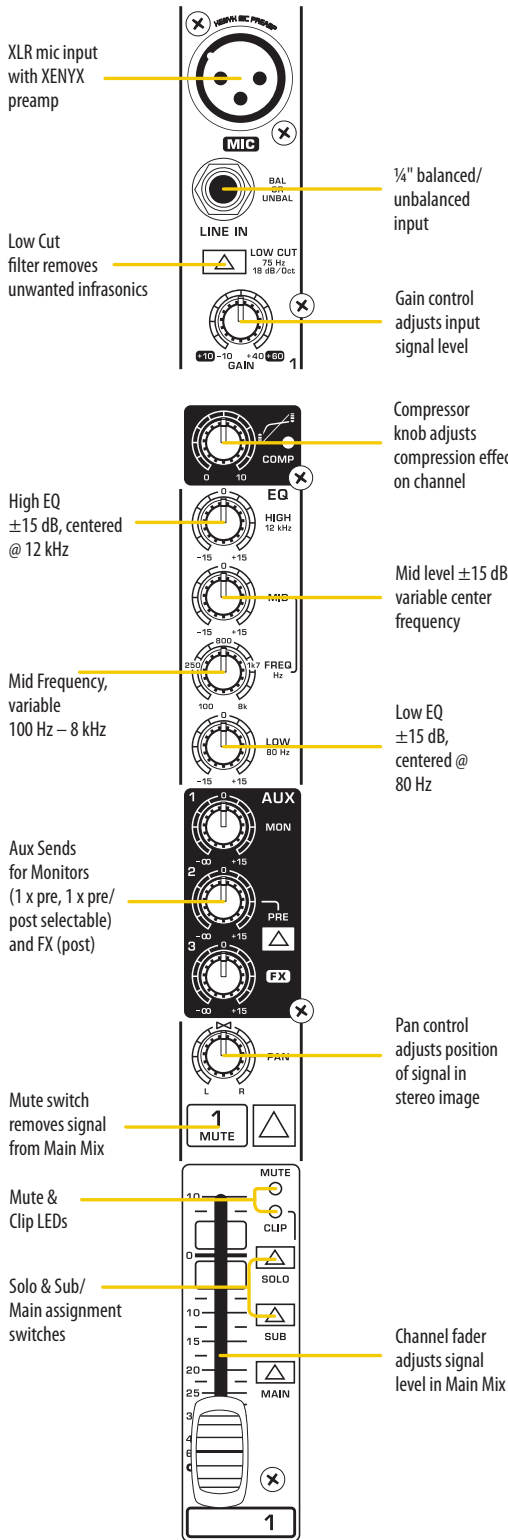

Onboard FX processor, 16 presets, two parameter controls

Aux Sends 1-3 with Solo switches

Phones/CTRL Room level control

Phones/CTRL Room source mixing matrix

Sub 1-2 Left/Right assignment switches

VU meter mode switch

Sub 1-2 faders

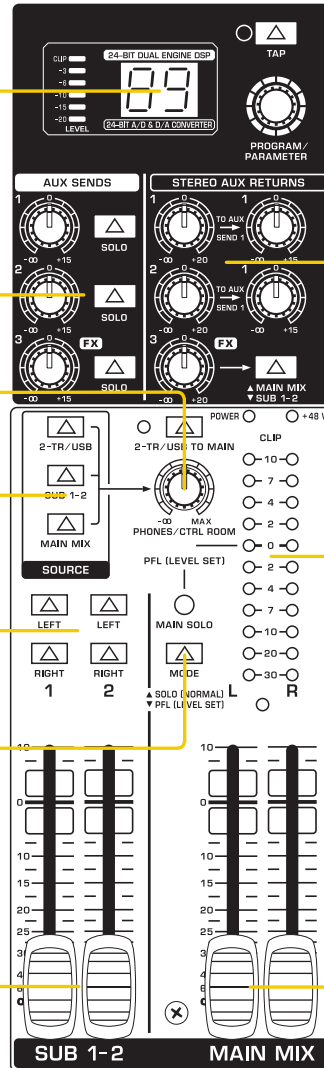

Stereo Aux Returns 1-3 with additional routing options

12-tier VU meter with +48 V and Power LEDs

Main Mix faders

XENYX X2442USB X2222USB / X1832USB X1622USB / X1222USB X1204USB / 1204USB

X2222USB Rear Panel

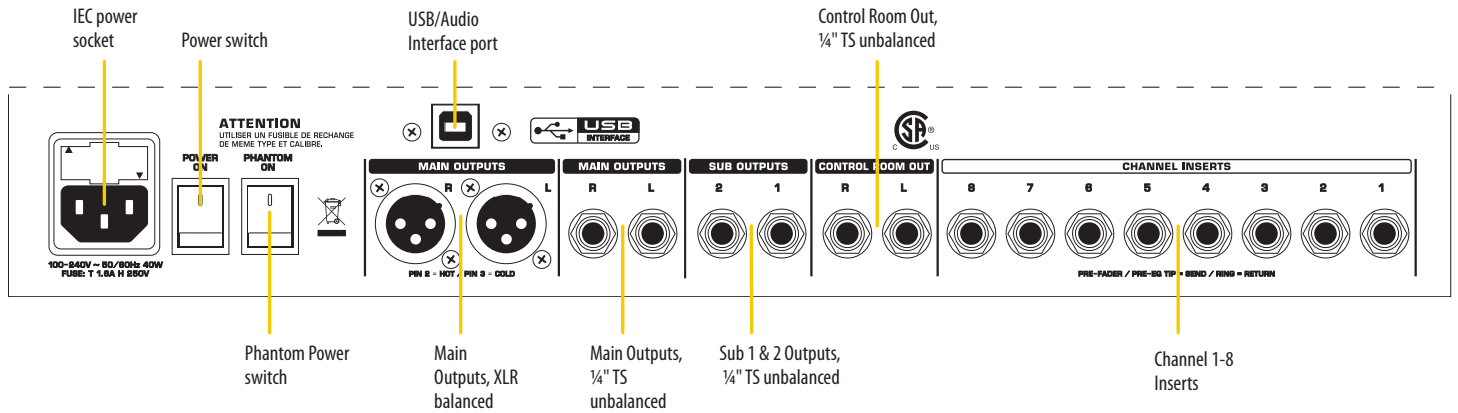

XENYX X2222USB Recording Setup

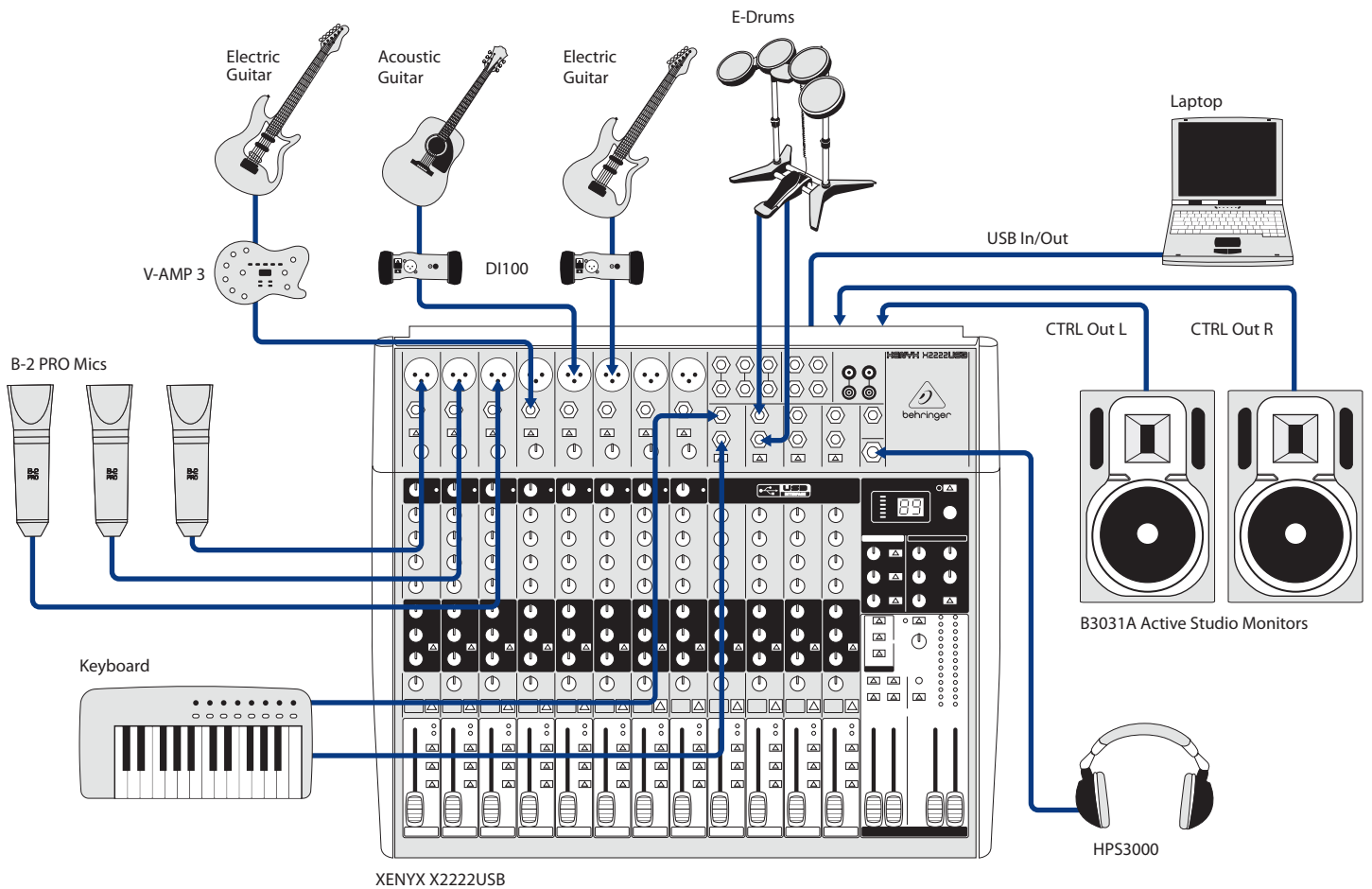

XENYX X2442USB X2222USB / X1832USB X1622USB / X1222USB X1204USB / 1204USB

X2442USB

The “Big Daddy” of the USB Series is the X2442USB with its 10 state-of-the-art, XENYX-powered mic inputs, four stereo channels, four Aux Sends and four stereo Aux Returns, and our easy to use “one knob” compressors on each of the mono channels. Other features available exclusive to the X2442USB are: four subgroups for mixing flexibility; Main Inserts (the ideal path

for connecting graphic equalizers or compressor/limiters); and eight Direct Outs and Sub Outs for analog recording purposes.

No matter what your audio mixing needs are, BEHRINGER USB Series mixers provide the performance and features that can take your talent to the next level, at a price that is sure to amaze you.

Try one on today—we have one available in your size!

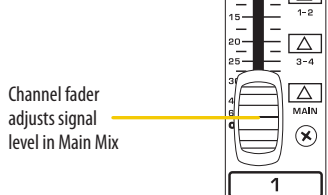
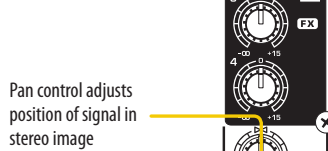
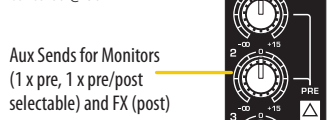
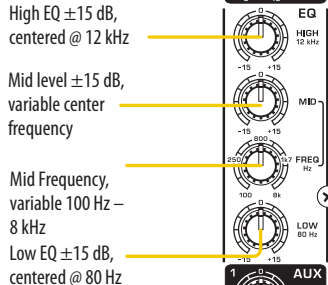
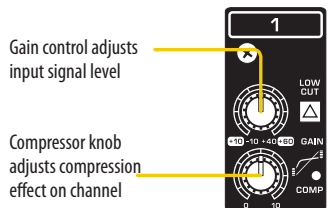
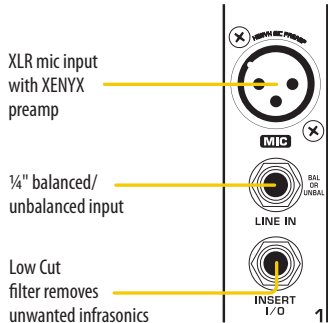

X2442USB Front Panel

Onboard FX processor, 16 presets, two parameter controls

Aux Sends 1-4 with Solo switches

Phones/CTRL Room level control

Phones/CTRL Room source mixing matrix

VU meter mode switch

Sub 1-4 (5-8) Left/Right assignment switches

Sub 1-4 (5-8) faders

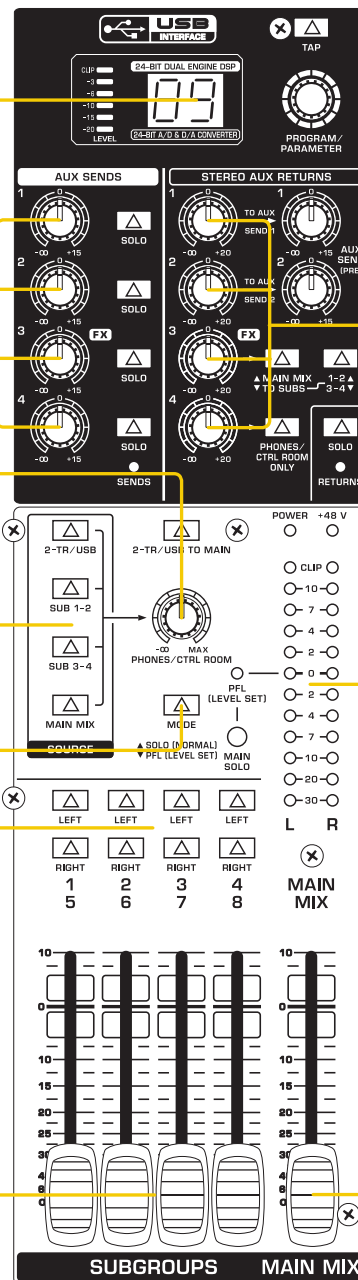

Stereo Aux Returns 1-4 with additional routing options

12-tier VU meter with +48V and Power LEDs

Main Mix faders

XENYX X2442USB X222USB / X1832USB X1622USB / X1222USB X1204USB / 1204USB

X2442USB Rear Panel

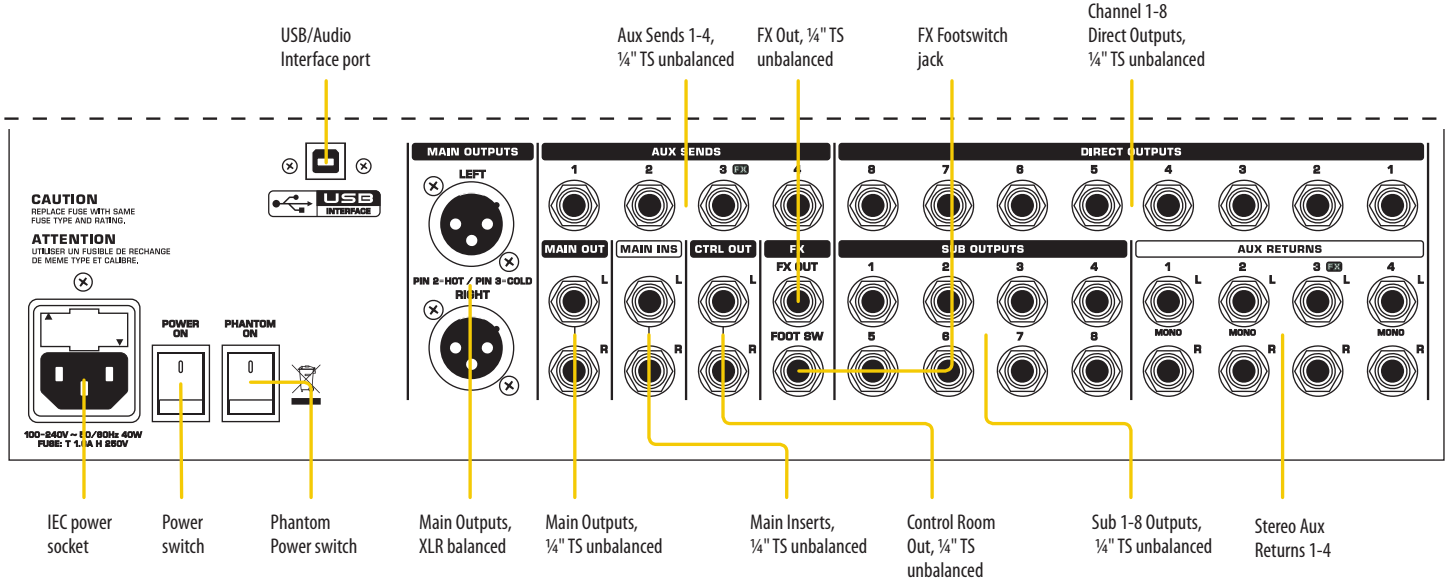

XENYX X2442USB Recording Setup

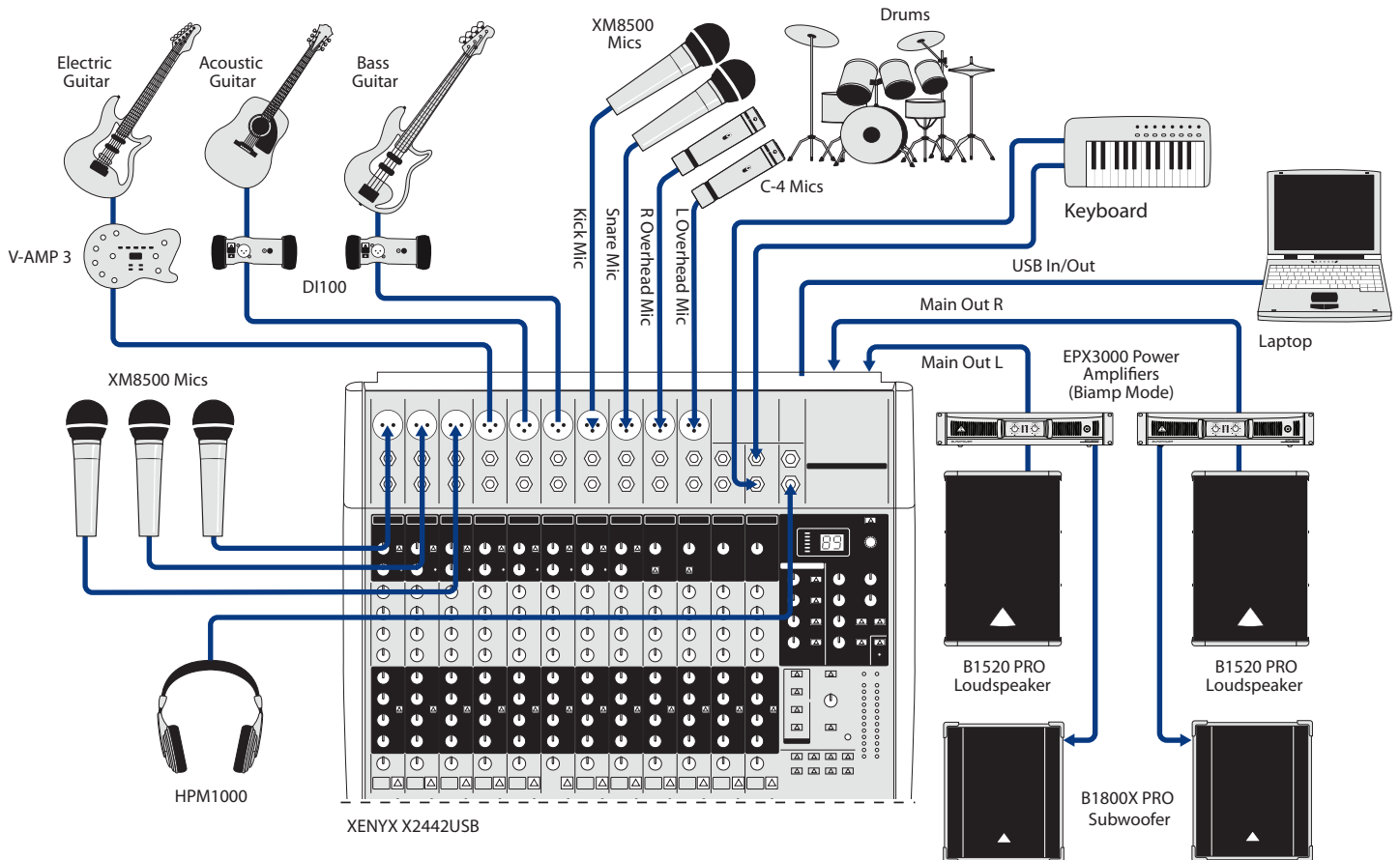

XENYX X2442USB X2222USB / X1832USB X1622USB / X1222USB X1204USB / 1204USB

Specifications

Mono Inputs

Microphone inputs (XENYX Mic preamp)	
Type	XLR connector, electronically balanced, discrete input circuit
Mic E.I.N.1 (20 Hz - 20 kHz)	
@ 0 Ω source resistance	-134 dB 135.7 dB A-weighted
@ 50 Ω source resistance	-131 dB 133.3 dB A-weighted
@ 150 Ω source resistance	-129 dB 130.5 dB A-weighted
Frequency response (-1 dB)	<10 Hz - 150 kHz (-1 dB)
Frequency response (-3 dB)	<10 Hz - 200 kHz (-3 dB)
Gain range	+10 dB to +60 dB
Max. input level	+12 dBu @ +10 dB GAIN
Impedance	2.6 k Ohms balanced
Signal-to-noise ratio	110 dB A-weighted (0 dBu In @ +22 dB GAIN)
Distortion (THD+N)	0.005% / 0.004% A-weighted
Phantom Power	Switchable, +48 V

Line Input

Type	¼" TRS jack, electronically balanced
Impedance	20 k Ohms balanced, 10 k Ohms unbalanced
Gain range	-10 dB to +40 dB
Max. input level	30 dBu

Frequency Response (Mic In – Main Out)

<10 Hz - 90 kHz	+0 dB / -1 dB
<10 Hz - 160 kHz	+0 dB / -3 dB

Stereo Inputs

Type	¼" TRS jack, balanced
Impedance	20 k Ohms balanced, 10 k Ohms unbalanced
Gain range	-20 dB to +20 dB
Max. input level	+22 dBu

CD/Tape In

Type	RCA connector
Impedance	10 k Ohms
Max. input level	+22 dBu

Equalizer 3-band

LOW	80 Hz / \pm 15 dB
MID	2.5 kHz / \pm 15 dB
HIGH	12 kHz / \pm 15 dB

Equalizer 3-band Semi-Parametric

LOW	80 Hz / \pm 15 dB
FREQ	Variable 100 Hz - 8 kHz
MID	/ \pm 15 dB
HIGH	12 kHz / \pm 15 dB

Equalizer 4-band Fixed

LOW	80 Hz / \pm 15 dB
LOW MID	500 Hz / \pm 15 dB
HIGH MID	3 kHz / \pm 15 dB
HIGH	12 kHz / \pm 15 dB

AUX Sends

Type	¼" mono jack, unbalanced
Impedance	120 Ohms
Max. output level	+22 dBu

AUX Returns

Type	¼" TRS connector, balanced
Impedance	20 k Ohms balanced, 10 k Ohms unbalanced
Max. input level	+22 dBu

Main Outputs

Type	XLR, electronically balanced
Impedance	240 Ohms balanced, 120 Ohms balanced
Max. output level	+28 dBu

Control Room Output

Type	¼" TS connector, unbalanced
Impedance	120 Ohms
Max. output level	+22 dBu

Phones Output

Type	¼" TRS jack, unbalanced
Max. output level	+19 dBu / 150 Ohms (+25 dBm)

CD/Tape Out

Type	RCA connector
Impedance	1 k Ohms
Max. output level	+22 dBu

DSP

Converter	24-bit Texas Instruments 24-bit Sigma-Delta 64/128-times oversampling
Sampling Rate	40 kHz

Main Mix System Data (Noise)

Main mix @ $-\infty$, @ $-\infty$ A weighted	-105 dB / -108 dB channel fader
Main mix @ 0 dB, @ $-\infty$ A weighted	-95 dB / -97 dB channel fader
Main mix @ 0 dB, @ 0 dB A weighted	-82.5 dB / -85 dB channel fader

Power Supply

Mains voltage	100 - 230 V~, 50/60 Hz
Mains connector	Standard IEC receptacle

USB

Connector	Type B
Converter	16-bit
Sample Rate	48 kHz

Please note these specifications are preliminary and conceptual in nature, and as such are subject to change as product development progresses. This information is supplied for market research purposes only and is not to be made public in any manner. This document is solely the property of The MUSIC Group, or one of its subsidiaries, and must be surrendered upon request of the owner.

For service, support or more information contact the BEHRINGER location nearest you:

Europe
MUSIC Group Services UK
Tel: +44 156 273 2290
Email: CARE@music-group.com

USA/Canada
MUSIC Group Services NV Inc.
Tel: +1 702 800 8290
Email: CARE@music-group.com

Japan
MUSIC Group Services JP K.K.
Tel: +81 3 6231 0454
Email: CARE@music-group.com

Technical specifications and appearances are subject to change without notice and accuracy is not guaranteed. BEHRINGER is part of the MUSIC Group (music-group.com). All trademarks are the property of their respective owners. MUSIC Group accepts no liability for any loss which may be suffered by any person who relies either wholly or in part upon any description, photograph or statement contained herein. Colors and specifications may vary from actual product. MUSIC Group products are sold through authorized fulfillers and resellers only. Fulfillers and resellers are not agents of MUSIC Group and have absolutely no authority to bind MUSIC Group by any express or implied undertaking or representation. This manual is copyrighted. No part of this manual may be reproduced or transmitted in any form or by any means, electronic or mechanical, including photocopying and recording of any kind, for any purpose, without the express written permission of MUSIC Group IP Ltd. ALL RIGHTS RESERVED. © 2012 MUSIC Group IP Ltd. Trident Chambers, Wickhams Cay, P.O. Box 146, Road Town, Tortola, British Virgin Islands.

behringer.com

