

Operating Instructions

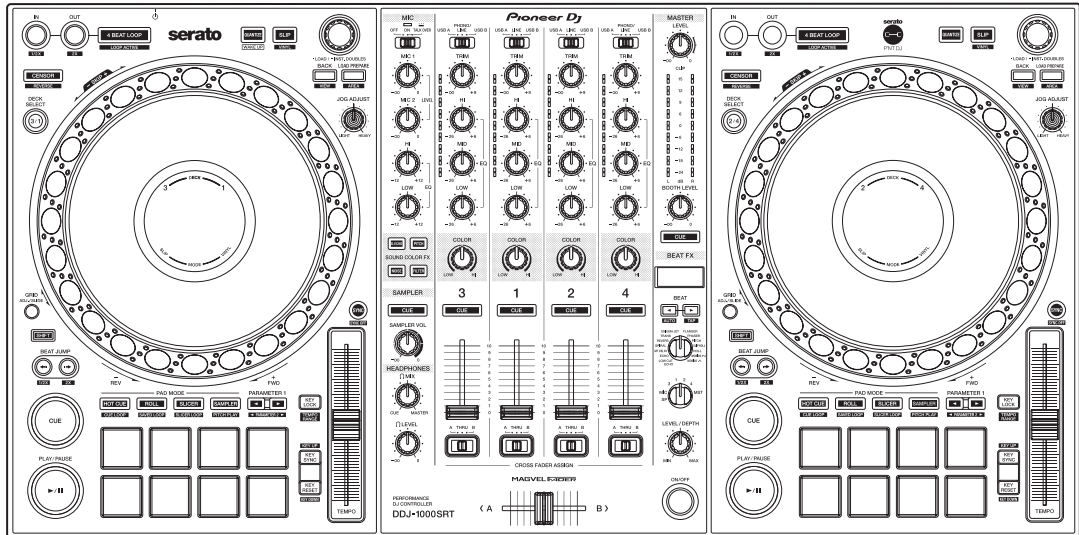

DJ Controller

DDJ-1000SRT

pioneerdj.com/support/
<http://serato.com/>

For FAQs and other support information for this product, visit the above websites.

Pioneer Dj

serato

How to read this manual

Thank you for choosing this Pioneer DJ product.

- Be sure to read this manual and the “Operating Instructions (Quick Start Guide)” which are also included with this product. Both documents include important information that you should understand before using the unit. In particular, be sure to read the **IMPORTANT SAFETY INSTRUCTIONS**.
- In this manual, the names of buttons, knobs and terminals that appear on the product, and the names of buttons, menus, etc. in the software on your PC/Mac are indicated within square brackets ([]). (e.g. **[Files]**, **[CUE]** button)
- Please note that the screens and specifications of the software, as well as the external appearance and specifications of the hardware, were still under development at the time this manual was created and may differ from the final specifications.
- Please note that, depending on the operating system version, web browser settings, etc., operation may differ from the ways shown in this manual.
- Please note that the language on the screens of the software described in this manual may differ from the language on your screen.

This manual provides brief descriptions regarding the names of parts on the unit and the connections between the unit and peripherals.

For detailed instructions on using Serato DJ Pro software, see the Serato DJ Pro software manual.

- **You can download the Serato DJ Pro software manual from Serato.com. For details on how to find the Serato DJ Pro software manual, see: Downloading the Serato DJ Pro software manual (page 6)**

Contents

How to read this manual	2
Before you start.....	5
What's in the box	5
Acquiring the manual	6
Installing the software	7
Part names and functions	15
Top panel.....	15
Browser section	16
Deck section	18
Jog display section	26
Mixer section.....	28
Rear panel	33
Front panel.....	36
Basic use.....	37
Connection examples	38
Launching the system.....	45
Quitting the system.....	52
Advanced use	53
Using 4 Beat Loop	53
Using Manual Loop.....	54
Using the Performance Pads.....	56
Using Pitch Play.....	67
Using Slip.....	69
Using Fader Start.....	74
Using effects	76
Using BEAT FX.....	76
Types of BEAT FX	79

Using SOUND COLOR FX	89
Using a microphone	91
Using external inputs	92
Changing the settings.....	94
Launching Utilities mode.....	94
Utilities modes	95
Setting utility software.....	108
Setting Crossfader Curve	111
Additional information	112
Troubleshooting	112
Liquid crystal display.....	119
Signal flow	120
Using the unit as a controller for other DJ applications	121
About trademarks and registered trademarks	128
Cautions on copyrights	129

Before you start

What's in the box

- AC adapter
- Power plug
- USB cable^{*1}
- Warranty (for some regions)^{*2}
- Operating Instructions (Quick Start Guide)
- Serato DJ Pro Expansion Pack Voucher^{*3}

^{*1} Only one USB cable is supplied with the unit. If you want to use two, use a cable that supports USB 2.0.

^{*2} Only products in Europe.

– For the North American region, the corresponding information is provided on the last page of both the English and French versions of the “Operating Instructions (Quick Start Guide).”

^{*3} Please note that the Serato DJ Pro Expansion Pack Voucher can't be reissued. You'll need to use the voucher code to activate the expansion pack. Be sure to store it in a safe place.

Acquiring the manual

Downloading the Serato DJ Pro software manual

- 1 Visit the Serato website.
<http://serato.com/>
- 2 Click **[Serato DJ Pro]** in the **[Products]** menu.
- 3 Click **[Download]**.
- 4 Click **[Manuals and downloads]**.
- 5 Click the Serato DJ Pro software manual in the language you need.

Installing the software

Before you install the software

The Serato DJ Pro software and driver software aren't included with the unit.

Access and download the software from the Pioneer DJ support page.
pioneerdj.com/support/

- You are responsible for preparing your PC/Mac, network devices, and other elements needed to connect to the internet.

Downloading the driver software

- 1 Launch a web browser on your PC/Mac and visit the Pioneer DJ website.
pioneerdj.com
 - To select your language, click the flag icon in the top-right corner of the screen.
- 2 Hover the cursor over **[Support]**.
- 3 Click **[Software & firmware updates]**.
- 4 Click **[DDJ-1000SRT]** under **[DJ CONTROLLER]**.
- 5 Click **[Drivers]**.
- 6 Click **[Download link]**, then save the file.

About the Serato DJ Pro software

Serato DJ Pro is a DJ software application made by Serato Limited. DJ performances are enabled by connecting the unit to your PC/Mac with the software installed.

Minimum computer requirements

Supported operating systems	CPU and memory required
Mac: macOS Mojave 10.14 / macOS High Sierra 10.13 / macOS Sierra 10.12 (latest update)	Intel [®] processor Core™ i3, i5, i7 and i9 1.07 GHz or better
	4 GB or more of RAM
Windows: Windows [®] 10 / Windows [®] 8.1 / Windows [®] 7 (latest service pack)	Intel [®] processor Core™ i3, i5, i7 and i9 1.07 GHz or better
	4 GB or more of RAM

- 32-bit operating systems not supported.

Others	
USB port	Your PC/Mac must have a USB 2.0 port to connect with the unit.
Display resolution	Resolution of 1280 × 720 or greater
Internet connection	You'll need an internet connection to register your user account at Serato.com and to download the software.

- For information on the latest system requirements, compatibility, and supported operating systems of Serato DJ Pro, visit the website below.

<https://serato.com/dj/pro/downloads>

- Be sure to use the latest version and latest service pack for your operating system.
- Operation isn't guaranteed on all PC/Mac models, even if the system requirements are met.
- Depending on power-saving settings and other conditions of the PC/Mac, the CPU and hard disk may not provide sufficient processing capabilities. For laptops in particular, make sure the PC/Mac is in the best condition to provide constant high-level performance when using Serato DJ Pro (e.g. by keeping the AC power connected).
- To use the internet, you need a separate contract with an internet service provider, which you may have to pay for.

❖ Downloading the Serato DJ Pro software

- 1 Visit the Serato website.
<http://serato.com/>
- 2 Click **[Serato DJ Pro]** under **[Products]**.
The Serato DJ Pro download page is displayed.
 - The download page is subject to change.
- 3 Click **[DOWNLOAD v*.*]**.
- 4 Create a Serato.com user account.
 - If you've already registered an account, skip to step 6.
 - If you haven't finished registering your account, follow the steps below.
 - Following the instructions on the screen, enter your email address and create a password, then select the region where you live.
 - If you check **[Go backstage with Serato]**, you'll receive newsletters with the latest information on Serato Limited products.
 - Once you've finished registering your user account, you'll receive an email. Check the contents of the email.
 - Be careful not to forget the email address and password you used to register. You'll need them to update the software in future.

Before you start

- The personal information you entered when registering your user account may be collected, processed, and used based on the privacy policy on the Serato website.
- 5 Click the link in the email you received from Serato.com.
This takes you to the Serato DJ Pro download page.
 - 6 Log in.
Enter the email address and password you registered to log in to Serato.com.
 - 7 Select **[A laptop with a supported controller, mixer or interface]** on the download page, and click **[DOWNLOAD SERATO DJ PRO]** to download the software.

❖ Installation procedure (Mac)

Do not connect the unit to your Mac until installation is complete.

- Quit any other programs that are running on your Mac.
- 1 Unzip the downloaded driver software (DDJ1000SRTXXXdmg.zip).
 - 2 Double-click **[DDJ-1000SRT_M_X.X.X.dmg]**.
 - 3 Double-click **[DDJ-1000SRT_AudioDriver.pkg]**.
 - 4 Follow the on-screen instructions to install.
 - 5 Unzip the downloaded Serato DJ Pro software file.
 - 6 Double-click the unzipped software file to launch the installer.

- 7 Read the terms of the license agreement carefully, and if you agree, click **[Agree]**.

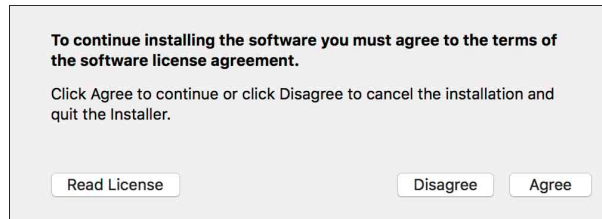

- If you don't agree to the contents of the license agreement, click **[Disagree]** to cancel the installation.

- 8 Click **[Install]**.

- 9 Follow the on-screen instructions to install.

- 10 Click **[Close]** to quit the installer.

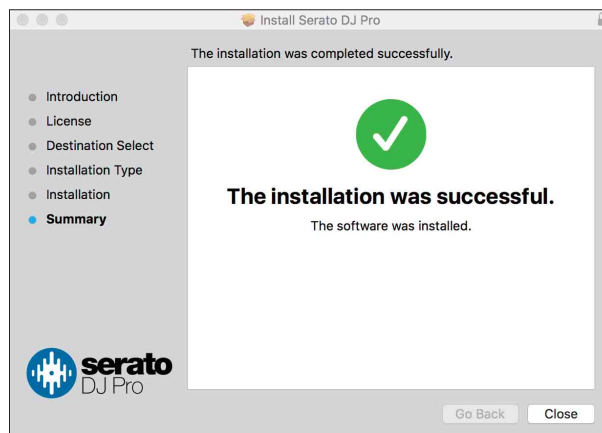

❖ Installation procedure (Windows)

Do not connect the unit to your PC until installation is complete.

- Log in to the administrator account on your PC before starting installation.
- Quit any other programs that are running.

- 1 Unzip the downloaded driver software (DDJ1000SRTXXXexe.zip).

- 2 Double-click **[DDJ-1000SRT_X.XXX.exe]**.
- 3 Follow the on-screen instructions to install.
If **[Windows Security]** appears on the screen during installation, click **[Install this driver software anyway]** and continue with the installation.
When the installation program is finished, a completion message appears.
After installing the driver software, install the Serato DJ Pro software.
- 4 Unzip the downloaded Serato DJ Pro software file.
- 5 Double-click the unzipped software file to launch the installer.
- 6 Read the terms of the license agreement carefully, and if you agree, select **[I agree to the license terms and conditions]**, then click **[Install]**.
 - If you don't agree to the contents of the license agreement, click **[Close]** to cancel the installation.

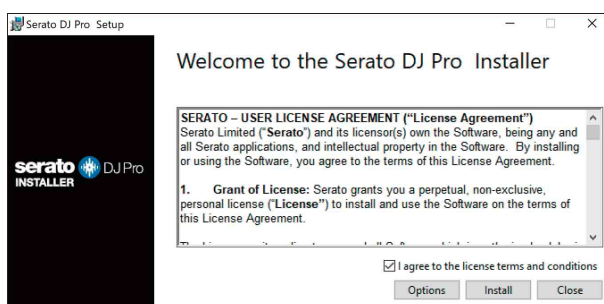

A message indicating successful installation appears when installation is complete.

- 7 Click **[Close]** to quit the Serato DJ Pro installer.



Installing the driver software on macOS Mojave 10.14 / macOS High Sierra 10.13

A new security feature has been added to macOS Mojave 10.14 / macOS High Sierra 10.13.

When installing Pioneer DJ driver software on these versions of macOS, driver software authentication is required.

If you're installing the driver software for the first time and you're using macOS Mojave 10.14 / macOS High Sierra 10.13, you need to follow the steps below. If the driver software was installed on macOS or OS X before you updated to macOS Mojave 10.14 / macOS High Sierra 10.13, you don't need to follow these steps.

- 1 Install Pioneer DJ's driver software in macOS Mojave 10.14 or macOS High Sierra 10.13.

The following dialog box will appear during driver software installation.



- 2 Click **[Open Security Preferences]**.

The **[Security & Privacy]** dialog box is displayed.

- 3 Check that **[System software from developer “Pioneer DJ Corporation” was blocked from loading.]** appears at the bottom of the screen.

This message will be displayed for 30 minutes after you start the installation of the driver software.

If it is not displayed, reinstall the driver software.

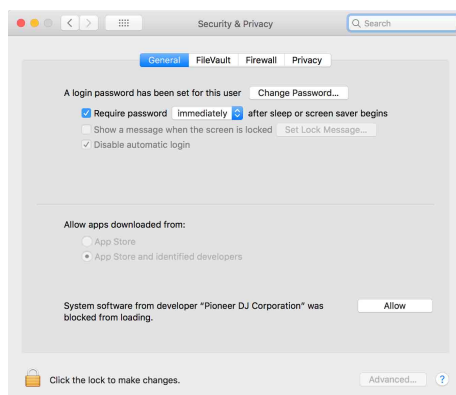

- 4 Click **[Allow]** at the bottom right of the screen.
- 5 When this unit is connected to a Mac, disconnect the USB cable and then reconnect it again.

Part names and functions

Top panel

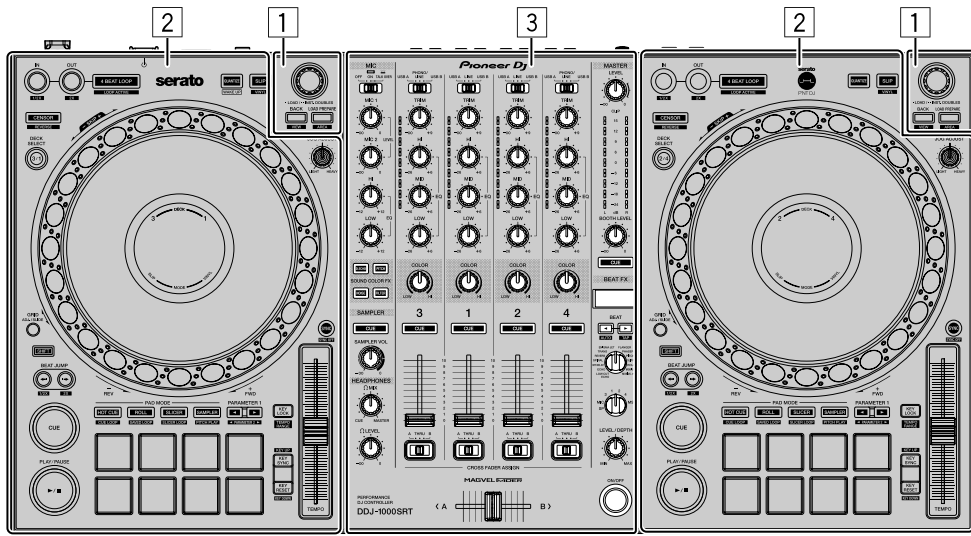

- 1** Browser section (page 16)
- 2** Deck section (page 18)
- 3** Mixer section (page 28)

Browser section

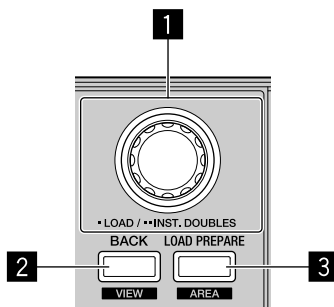

1 Rotary selector

Turn:

Moves the cursor up or down in the library or in the **[crates]** panel.

Press:

Loads the selected track onto a deck.

When the cursor is in the **[crates]** panel, the cursor is moved to the library.

Press twice:

Loads the track onto the deck being played from the deck not being played.

When the track is loaded, the playback position isn't changed.

2 BACK button

Press:

Move the cursor between the library and **[crates]** panel each time you press the button.

If there are sub-crates for the item currently selected in the **[crates]** panel, those crates are expanded or collapsed.

When the cursor is in the **[Files]** panel, the cursor moves to a higher layer.

When the cursor is in the **[Browse]** panel, the cursor moves to the previous category.

[SHIFT] + press:

Changes the screen layout of Serato DJ Pro.

3 LOAD PREPARE button

Press:

Loads a track onto the **[Prepare]** panel.

[SHIFT] + press:

Changes the panel of Serato DJ Pro.

No panel → **[Files]** panel → **[Browse]** panel → **[Prepare]** panel →

[History] panel → No panel

Deck section

You can control four decks with the unit. There are knobs and buttons on the left side to control decks 1 and 3, and on the right side to control decks 2 and 4.

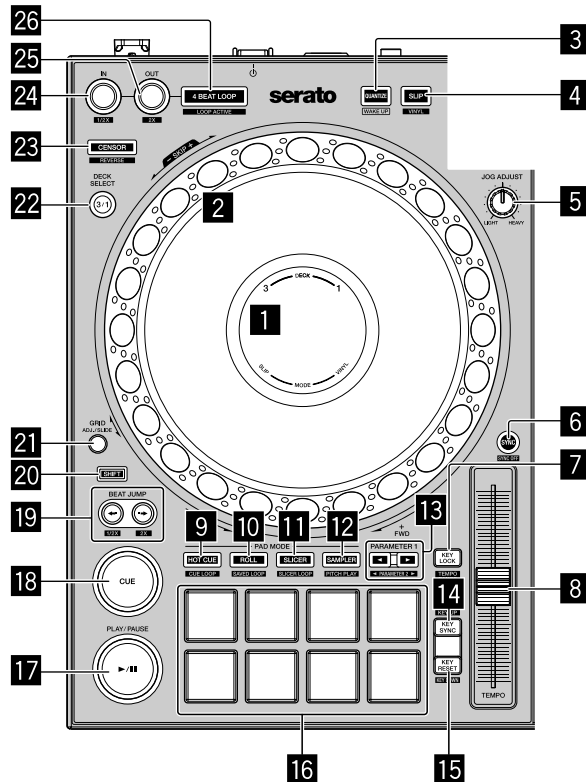

1 On Jog Display

➔ Read more: Jog display section (page 26)

2 Jog wheel

Turn the top:

‘Scratches’ when VINYL mode is on.

Bends the pitch or ‘Pitch Bend’ (slows down or speeds up the track) when VINYL mode is off.

Turn the outer section:

Bends the pitch or ‘Pitch Bend’ (slows down or speeds up the track).

[SHIFT] + turn the top:

The playback position skips in sync with the beat. (Skip mode)

- Skip mode can't be used with tracks for which no beatgrid is set. For details on setting beatgrids, see the Serato DJ Pro software manual.
- To use Skip mode, open the **[SETUP]** menu of Serato DJ Pro > **[SYNC PREFERENCES]** and select **[Smart Sync]**.

3 **QUANTIZE button**

Press:

Turns the Quantize function on/off.

Press (during Standby mode):

Cancels Standby mode.

- This action can only be used on the left deck.

4 **SLIP button**

Press:

Turns Slip mode on/off.

➤ Read more: Using Slip (page 69)

[SHIFT] + press:

Turns VINYL mode on/off.

5 **JOG ADJUST knob**

Adjusts the load applied when the jog wheel is turned.

Turn the knob clockwise to increase the load, or turn the knob counter-clockwise to decrease the load.

6 **SYNC button**

Press:

Automatically synchronizes the tempos (BPM) and beatgrids with a track on one of the other decks.

[SHIFT] + press:

Cancels Sync mode.

7 KEY LOCK button

Press:

Turns the Key Lock function on/off.

When the Key Lock function is on, the key doesn't change even when the playing speed is changed using the **[TEMPO]** slider.

- The sound is digitally processed, so the sound quality decreases.

[SHIFT] + press:

Switches the range of the **[TEMPO]** slider each time the button is pressed while holding the **[SHIFT]** button.

Switch between **[±8%]** → **[±16%]** → **[±50%]** → **[±8%]**.

Hold down for at least one second:

Sets the tempo (BPM) of the currently playing track back to its original tempo.

8 TEMPO slider

Adjusts the playing speed of the track.

9 HOT CUE mode button

Press:

Sets Hot Cue mode.

➡ Read more: Using Hot Cues (page 56)

[SHIFT] + press:

Sets Cue Loop mode.

➡ Read more: Using Cue Loop (page 63)

10 ROLL mode button

Press:

Sets Roll mode.

[SHIFT] + press:

Sets Save Loop mode.

11 SLICER mode button

Press:

Sets Slicer mode.

[SHIFT] + press:

Sets Slicer Loop mode.

- To cancel Slicer mode and Slicer Loop mode, press the **[ROLL]** mode button, **[SAMPLER]** mode button or **[HOT CUE]** mode button.

12 SAMPLER mode button

Press:

Sets Sampler mode.

➡ Read more: Using the Sampler (page 62)

[SHIFT] + press:

Sets Pitch Play mode.

➡ Read more: Using Pitch Play (page 67)

13 PARAMETER◀, ▶ buttons

Sets the parameter for Loop Roll, Slicer, Sampler and other functions.

➡ Read more: Using the Performance Pads (page 56)

14 KEY SYNC button

Press:

Changes the key to match one of the other decks.

[SHIFT] + press:

Turns up the key.

15 KEY RESET button

Press:

When this button is pressed during Key Sync, the key returns to its original key.

[KEY SYNC] and **[KEY RESET]** buttons are used for the Pitch 'n Time function. To use this function, you'll need to activate Pitch 'n Time. For more details, read the Pitch 'n Time DJ Activation Manual under **[Extra software information]** on the Pioneer DJ support page.

pioneerdj.com/support/

The key of the currently playing track of the selected deck returns to its original key.

[SHIFT] + press:

Turns down the key.

16 Performance Pads

You can use Performance Pads to trigger various features.

➔ Read more: Using the Performance Pads (page 56)

17 PLAY/PAUSE ►/|| button

Press:

Plays/pauses a track.

[SHIFT] + press:

Returns to the temporary cue point and playback starts. (Stutter)

18 CUE button

Press:

Sets, plays and calls up a temporary cue point.

- Press this button when the track is paused to set the temporary cue point.
- Press this button when the track is playing to return to the temporary cue point and pause. (Back Cue)
- Press this button and hold it after the track returns to the temporary cue point and playback will continue until you release the button. (Cue Sampler)
- When you press the **[PLAY/PAUSE ►/||]** button during the Cue Sampler, playback continues from that point.

Part names and functions

[SHIFT] + press:

Loads the previous track from the track list. (Previous Track)

- The playback position returns to the beginning of the track.

19 BEAT JUMP ← (1/2X), BEAT JUMP → (2X) buttons

Press:

Changes the playback position by the set beat(s).

[SHIFT] + **[BEAT JUMP ← (1/2X)]**:

Halves the beat for changing the playback position.

[SHIFT] + **[BEAT JUMP → (2X)]**:

Doubles the beat for changing the playback position.

20 SHIFT button

Press another button while holding the **[SHIFT]** button to use a different feature assigned to the button.

21 GRID button

Turn the top of the jog wheel while holding down the **[GRID]** button to adjust the interval of beatgrids.

Turn the outer section of the jog wheel while holding down the **[GRID]** button to slide the beatgrid to the right or left.

22 DECK SELECT button

Press:

Switches the deck to be used.

23 CENSOR button

Press:

Hold down the button to play the track in the reverse direction. Normal playback resumes when the button is released.

- Even during playback in the reverse direction, normal playback continues in the background. When the button is released, playback resumes from the point reached in the background.

[SHIFT] + press:

Plays the track in the reverse direction. When you press the **[SHIFT]** and **[CENSOR]** buttons again, reverse playback is canceled, and then normal playback resumes.

24 LOOP IN button

Press:

Sets a Loop In Point.

Press this button during loop playback to finely adjust the loop in point using the jog wheel.

[SHIFT] + press:

Halves the loop playback length.

25 LOOP OUT button

Press:

Sets a Loop Out Point and starts loop playback.

Press this button during loop playback to finely adjust the Loop Out point using the jog wheel.

[SHIFT] + press:

Doubles the loop playback length.

26 4 BEAT LOOP button

Press:

During normal playback, the auto beat loop of 4 beats is set, and then loop playback starts.

During the loop playback, the loop playback is canceled.

Part names and functions

[SHIFT] + press:

Switches the active or non-active status of the loop. (Loop Active)

- Even when the loop is set to active, loop playback doesn't start if the playback position isn't in the loop.
- When the playback position reaches the active loop, the loop playback starts.
- During the loop playback, the loop playback is canceled.

Jog display section

When a track is loaded, the following information is displayed on the jog display.

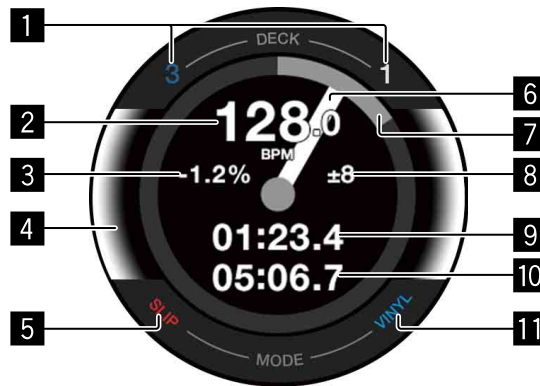

1 Deck number indicators

The number of the deck currently being used lights up.

2 BPM

Displays the current BPM.

3 Playing speed

The value changes according to the position of the [TEMPO] slider.

4 Selected deck

Indicates the selected deck by the background color.

- White: Deck 1 or 2 is selected.
- Blue: Deck 3 or 4 is selected.

5 SLIP indicator

Indicates the status of Slip mode.

- Lit up: Slip mode is on.
- Not lit: Slip mode is off.

6 Operation status

Shows the current playback position.

Rotates during playback, and stops when paused.

When the playback position reaches the set Hot Cue point, the operation status color changes to match the Hot Cue color.

When the playback position gets closer to the Hot Cue point, the color display area gets wider.

7 Playback position

Indicates the current playback position with the track length as one lap.

8 Playing speed adjustment range

Displays the range at which the playing speed can be adjusted.

9 Elapsed time

Displays the elapsed time.

10 Remaining time

Displays the remaining time.

11 VINYL indicator

Indicates the status of VINYL mode.

- Lit up: VINYL mode is on.
- Not lit: VINYL mode is off.

Mixer section

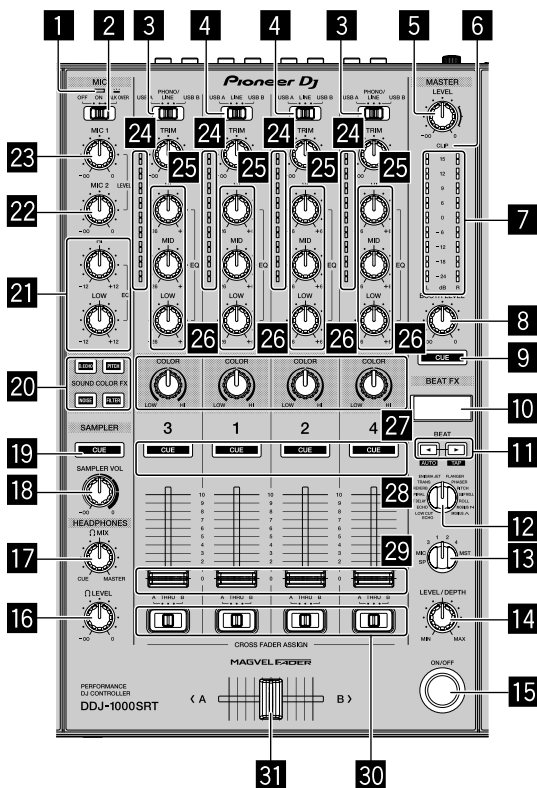

1 MIC (microphone) indicator

➡ Read more: Using a microphone (page 91)

2 MIC OFF, ON, TALK OVER switch

Turns the microphone on/off.

➡ Read more: Using a microphone (page 91)

3 USB A, PHONO/LINE, USB B switches

Selects the input source of each channel from devices connected to the unit.

- **[USB A]:** Select to use a track loaded onto a deck.
- **[PHONO/LINE]:** Select to use a phono level (for MM cartridge) output device such as a turntable connected to the **[LINE/PHONO]** input terminals.
 - ➡ Read more: Using external inputs (page 92)
- **[USB B]:** Select to use a track loaded onto a deck.

4 **USB A, LINE, USB B switches**

Selects the input source of each channel from the components connected to the unit.

- **[USB A]**: Select to use a track loaded onto a deck.
- **[LINE]**: Select to use a line level output device (DJ player, etc.) connected to the **[LINE]** input terminals.
 - ➡ Read more: Using external inputs (page 92)
- **[USB B]**: Select to use a track loaded onto a deck.

5 **MASTER LEVEL knob**

Adjusts the volume of the master output sound.

6 **CLIP indicator**

Flashes when the output level is too high.

- Slow flashing: Occurs just before the distortion of sound begins.
- Fast flashing: The sound is distorted.

7 **Master level indicator**

Indicates the volume of the master output sound.

8 **BOOTH LEVEL knob**

Adjusts the volume of the **[BOOTH]** output terminal sound.

9 **MASTER CUE button**

Plays the master sound through your headphones.

10 **BEAT FX display**

Displays an effect name, BPM, effect parameter, etc.

11 **BEAT ◀, ▶ buttons**

Press:

Increases or decreases the effect timing.

[SHIFT] + [BEAT ◀]:

Sets to automatically enter BPM by measuring from the input sound signal.

Part names and functions

[SHIFT] + [BEAT ►]:

Sets to manually enter BPM.

12 BEAT FX SELECT knob

Changes the effect type of Beat FX.

13 BEAT FX CH SELECT knob

Changes the channel to which you want to add Beat FX.

14 BEAT FX LEVEL/DEPTH knob

Adjusts the parameter of Beat FX.

15 BEAT FX ON/OFF button

Press:

Turns Beat FX on/off.

16 HEADPHONES LEVEL knob

Adjusts the volume of the headphones sound.

17 HEADPHONES MIX knob

Adjusts the balance of monitor sound level between the master channel and the channel for which the headphones **[CUE]** button is pressed.

18 SAMPLER VOL knob

Adjusts the volume of the sampler sound.

19 SAMPLER CUE button

Outputs the sampler sound from the headphones.

- Before using this button, set **[Sampler Player Output Select]** to **[A]** on Serato DJ Pro.

20 SOUND COLOR FX SELECT buttons

Turns Sound Color FX on/off.

➡ Read more: Using SOUND COLOR FX (page 89)

21 MIC EQ (HI, LOW) knobs

Adjusts the sound quality of **[MIC 1]** and **[MIC 2]** channels.

Part names and functions

22 MIC2 LEVEL knob

Adjusts the volume of the **[MIC 2]** channel sound.

23 MIC1 LEVEL knob

Adjusts the volume of the **[MIC 1]** channel sound.

24 Channel level indicators

Indicates the volume of the respective channel's sound before passing through the channel faders.

25 TRIM knobs

Adjusts the volume of each channel's sound.

26 EQ (HI, MID, LOW) knobs

Boosts or reduces the relevant frequency for the selected channel.

27 COLOR knobs

Changes the parameter of Sound Color FX for each channel.

28 Headphones CUE buttons

Press:

Plays the sound of the relevant channel through your headphones.

[SHIFT] + press:

Hold the **[SHIFT]** button and tap the button to set the tempo of the respective deck in time with your tapping. (Tap feature)

29 Channel faders

Adjusts the volume of each channel's sound.

30 CROSSFADER ASSIGN switches

Assigns the channel output to the crossfader.

[A]: Assigns output to **[A]** (left) of the crossfader.

[B]: Assigns output to **[B]** (right) of the crossfader.

[THRU]: Select this when you don't want to use the crossfader. (The signals don't pass through the crossfader.)

31 Crossfader

The sound assigned with the crossfader assign switch is output.

Don't forcibly pull out the channel fader and crossfader knobs. These knobs are hard to pull out and may be broken if forcibly pulled out.

Rear panel

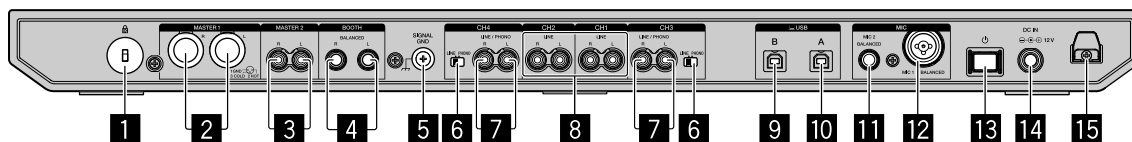

1 Kensington Security Slot

Connects a cable lock for security.

2 MASTER 1 output terminals

Connects a powered speaker, a power amplifier, etc.

- Compatible with XLR connector type balanced outputs.
Be sure to use these terminals as balanced outputs.
- **Be careful not to accidentally insert the power cord plug of another unit or device into any of these terminals.**
- **Do not connect devices capable of supplying phantom power to these terminals.**

3 MASTER 2 output terminals

Connects a powered speaker, a power amplifier, etc.

- Compatible with RCA pin-jack type unbalanced outputs.

4 BOOTH output terminals

Outputs for a booth monitor.

- Compatible with TRS connector type balanced outputs.
Be sure to use these as balanced outputs.
- Outputs the master channel sound from the **[BOOTH]** output terminals regardless of the volume of the master channel sound.
The volume can be adjusted using the **[BOOTH LEVEL]** knob.

5 SIGNAL GND terminal

Connects the ground wire of a turntable to reduce noise that occurs when a turntable is connected.

6 LINE/PHONO switch

Selects the input source for each channel from the devices connected to the unit.

- **[LINE]**: Used when a line level output device (DJ player, etc.) is connected to the **[LINE/PHONO]** input terminals.
- **[PHONO]**: Used when a phono level (for MM cartridges) output device (turntable, etc.) is connected to the **[LINE/PHONO]** input terminals.

7 LINE/PHONO input terminals

Connects a phono level (for MM cartridges) output device (turntable, etc.) or a line level output device (DJ player, etc.). You can switch the input source depending on the connected device using the **[LINE/PHONO]** switch on the rear panel of the unit.

- Set the **[USB A, PHONO/LINE, USB B]** switch on the top of the unit to **[PHONO/LINE]** beforehand.

8 LINE input terminals

Connects a DJ player or other line level device.

- Set the **[USB A, LINE, USB B]** switch on the top of the unit to **[LINE]** beforehand.

9 USB port (USB B)

Connects a PC/Mac.

- Connect this unit directly to your PC/Mac using the supplied USB cable or one that supports USB 2.0.
- A USB hub can't be used.

10 USB port (USB A)

Connects a PC/Mac.

- Connect this unit directly to your PC/Mac using the supplied USB cable or one that supports USB 2.0.
- A USB hub can't be used.

11 MIC2 input terminal

Connects a microphone.

- Only phone plugs (Ø 6.3 mm) can be used.

Part names and functions

12 MIC1 input terminal

Connects a microphone.

- Either an XLR connector or a phone plug (Ø 6.3 mm) can be used.

13 switch

Turns the power on or standby the unit.

14 DC IN terminal

Connects a power outlet using the supplied AC adapter (using the supplied power cord).

- Connect the AC adapter after all connections are completed.
- Use the supplied AC adapter.

15 Cord hook

Hook for the AC adapter power cord.

- If the AC adapter is disconnected during playback, the sound will be interrupted.

Front panel

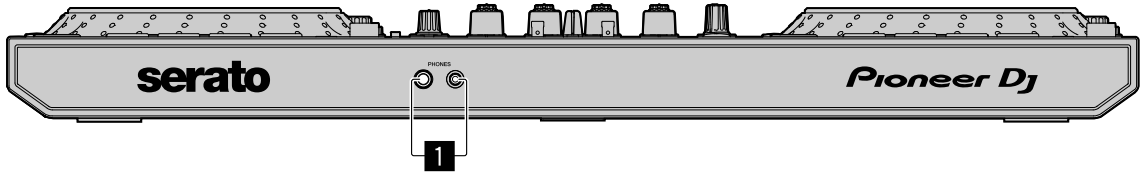

1 PHONES output terminals

Connects your headphones.

Stereo phone plugs (ø 6.3 mm) and stereo mini phone plugs (ø 3.5 mm) can be used.

Basic use

- Only connect the power cord to a power outlet after you've made all other connections.

Turn off the unit and disconnect the power cord from the outlet before connecting different devices or changing connections.

Refer to the operating instructions for any devices you want to connect.

- Be sure to use the supplied power cord and AC adapter.
- Be sure to use the supplied USB cable or one that supports USB 2.0.
- Do not use a USB hub.

Connection examples

Connecting input terminals

Rear panel

- (1) Turntable*¹, (2) Multi player*², (3) Multi player,
 (4) Portable audio device, (5) AC adapter (supplied),
 (6) Power cord (supplied), (7) To power outlet,
 (8) Portable audio device, (9) Multi player, (10) Turntable*¹,
 (11) Multi player*², (12) PC/Mac, (13) Microphone

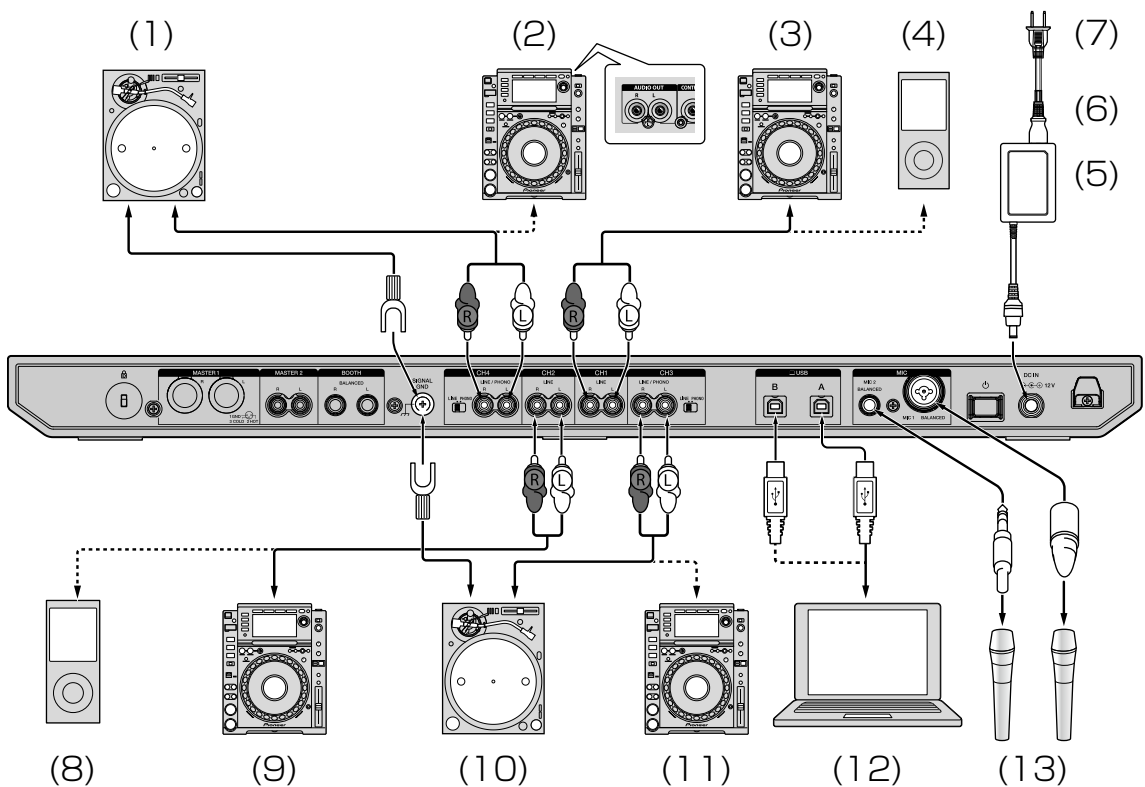

*¹ When connecting a turntable, set the **[LINE/PHONO]** switch beside the terminals to **[PHONO]**.

*² When connecting a multi player, set the **[LINE/PHONO]** switch beside the terminals to **[LINE]**.

Cord hook

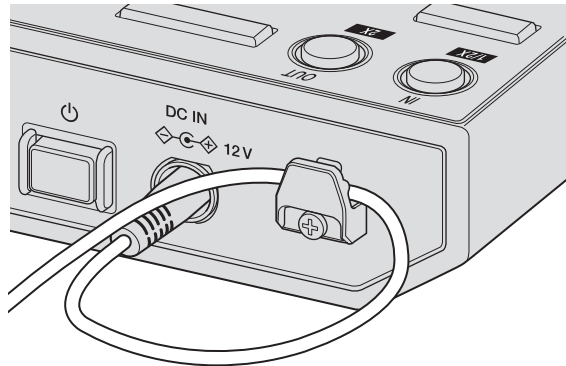

Hook the AC adapter's power cord onto the cord hook.

Fasten the AC adapter's power cord in place by hooking it onto the cord hook. This prevents the power cord from being accidentally pulled and the plug from being disconnected from the terminal.

- Do not bend the base of the AC adapter power cord when fastening it. If used continuously under these conditions, the power cord may be damaged, resulting in faulty contact.
- The sound will be interrupted if the AC adapter is disconnected during playback.

Connecting output terminals

Rear panel

- (1) Devices, amplifier, powered speakers, etc.,
- (2) Power amplifier, powered speakers, etc.,
- (3) Power amplifier (for booth monitor), powered speakers, etc.

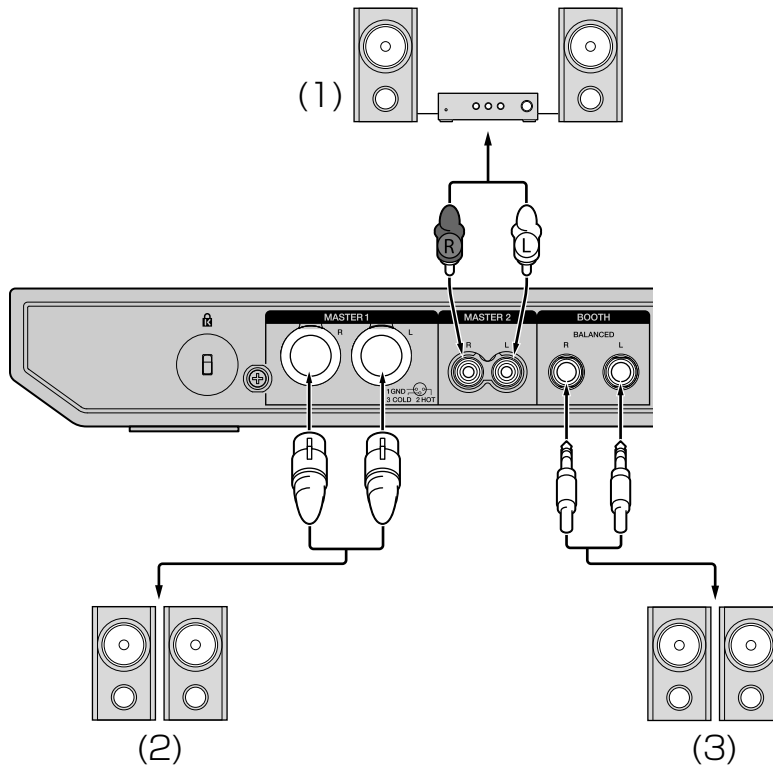

Front panel

(1) Headphones

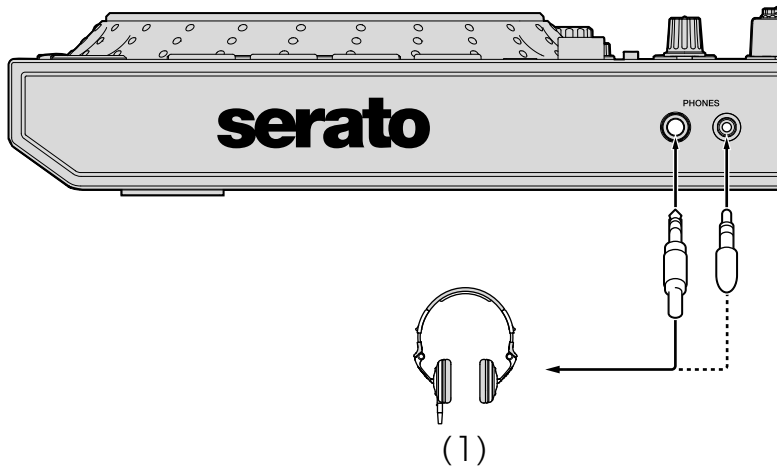

- 1 Be sure to use the **[MASTER 1]** output terminals for a balanced output.
 If these terminals are connected to an unbalanced input (such as RCA) using an XLR to RCA converter cable (or a converter adapter), etc., sound quality may decrease or noise may occur.
 To connect to an unbalanced input (such as RCA), use the **[MASTER 2]** output terminals.
- 2 Be careful not to accidentally insert the power cord plug of another unit or device into a **[MASTER 1]** output terminal.
 Do not connect devices capable of supplying phantom power to the **[MASTER 1]** output terminals.
- 3 Be sure to use the **[BOOTH]** output terminals for a balanced output.
 If these terminals are connected to an unbalanced input (such as an RCA or TS terminal) using a TRS to RCA converter cable (or a converter adapter), TS cable, etc., sound quality may decrease or noise may occur.

Connecting

- 1 Connect headphones to one of the **[PHONES]** output terminals

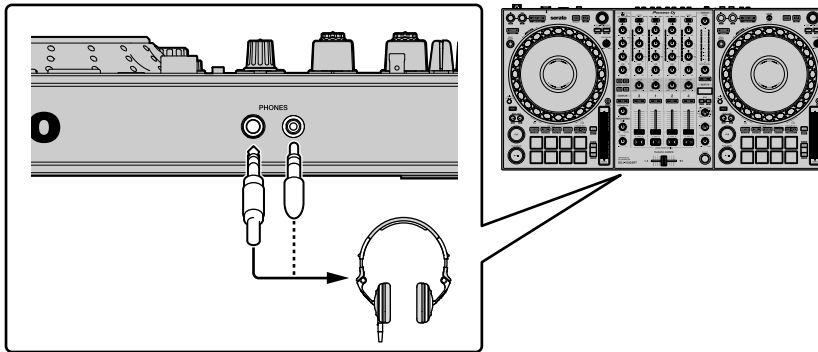

- 2 Connect powered speakers, a power amplifier, devices, etc. to the **[MASTER 1]** or **[MASTER 2]** output terminals.

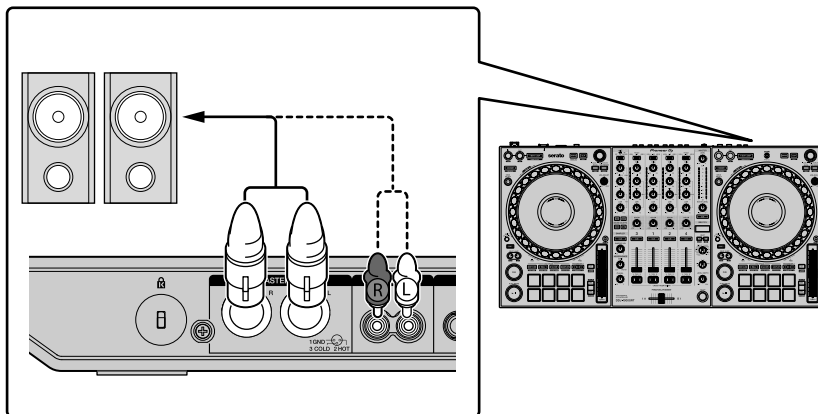

- To output the sound from the **[BOOTH]** output terminals, connect speakers or other devices to the **[BOOTH]** output terminals.

- 3 Connect the unit to your PC/Mac via a USB cable.

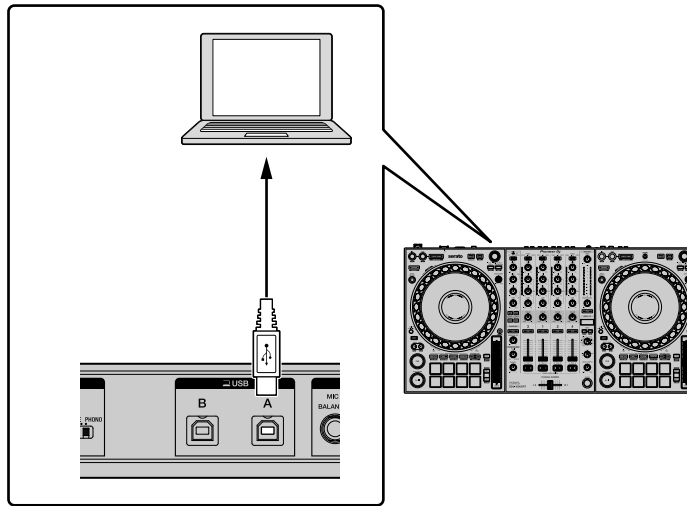

- 4 Turn on your PC/Mac.
- 5 Connect the AC adapter.

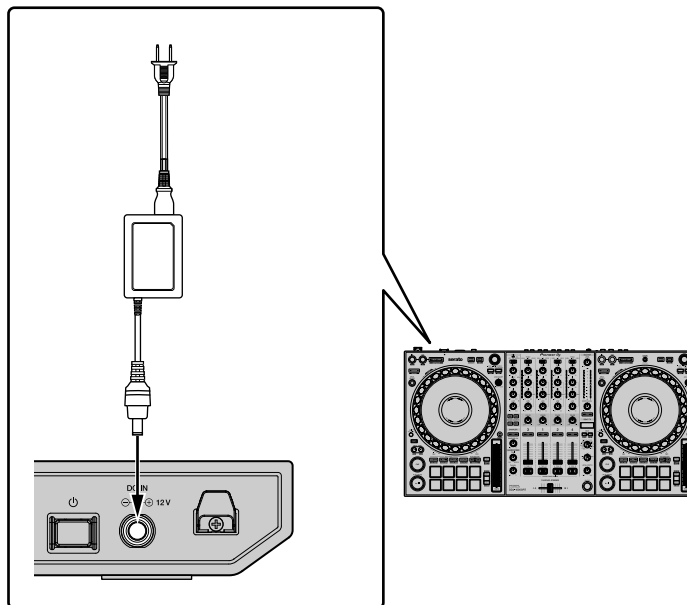

6 Press the [⏻] switch on this unit's rear panel to turn this unit on.

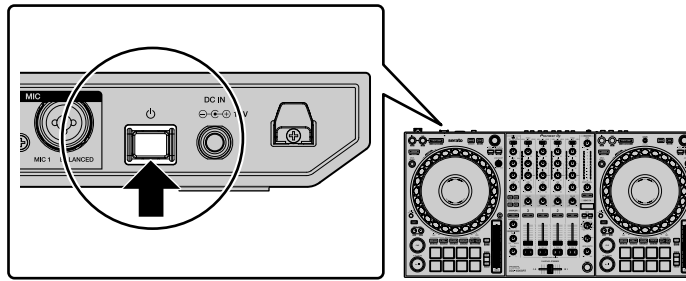

- For Windows users

The preparing device message may appear the first time you connect the unit to your PC or when you connect it to a different USB port. Wait until the ready-to-use message appears.

7 Turn on the devices connected to the output terminals (powered speakers, power amplifier, etc.).

- When a microphone, DJ player or other external device is connected to input terminals, turn on that device too.

Launching the system

Launching Serato DJ Pro

This manual mainly focuses on explaining the hardware functions of the unit. For detailed instructions on using the Serato DJ Pro software, see the Serato DJ Pro software manual.

For Mac

In Finder, open the **[Applications]** folder, then click the **[Serato DJ Pro]** icon.

For Windows 10

From the **[Start]** menu, click **[Serato] > [Serato DJ Pro]** icon.

For Windows 8.1

From **[Apps view]**, click the **[Serato DJ Pro]** icon.

For Windows 7

In the Windows **[Start]** menu, click **[All Programs] > [Serato] > [Serato DJ Pro]**.

The screen directly after the Serato DJ Pro software is launched

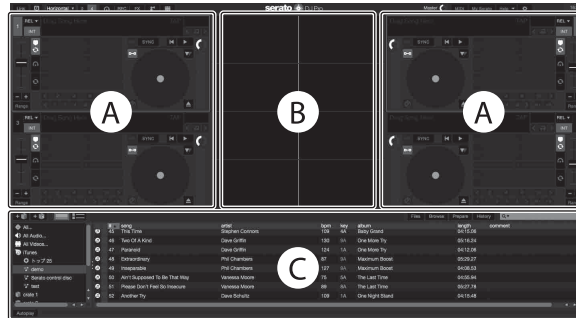

- The **[BUY/ACTIVATE]** icon may appear on the right side of the screen when you launch Serato DJ Pro for the first time. However, you don't need a license to use the DDJ-1000SRT. You can buy expansion packs such as DVS and use them as additional options.

The screen when tracks are loaded onto decks in the Serato DJ Pro software

Click **[Library]** in the top-left corner of the screen, then select **[Vertical]** or **[Horizontal]** from the pull-down menu to change the Serato DJ Pro screen.

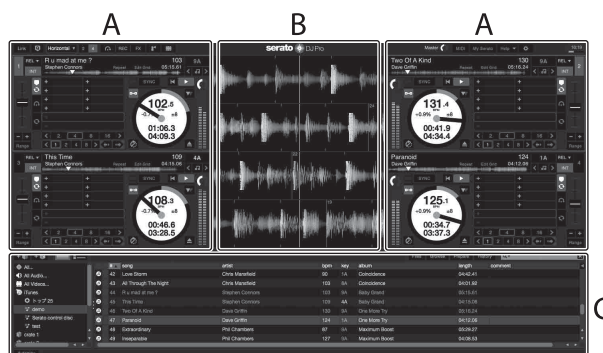

A Deck section

The track information (track name, artist name, BPM, etc.), the overall waveform and other information of the loaded track are displayed.

B Waveform display

The waveform of the loaded track is displayed.

C Browser section

Tracks in the library, or crates containing multiple tracks, are displayed.

Importing music files (tracks)

- There are various ways to import tracks into Serato DJ Pro. For details, see the Serato DJ Pro manual.
- If you're already using Serato Limited's DJ software (e.g. Scratch Live, ITCH, Serato DJ Intro, or Serato DJ Lite) and you've already created track libraries, you can use these libraries.
- If you're using Serato DJ Lite and you've already created track libraries, you may need to reanalyze tracks.

The typical way to import music files (tracks) is as follows.

- 1 Click the **[Files]** key in the Serato DJ Pro screen to open the **[Files]** panel.
The contents of your PC/Mac or the hard drive/device connected to the PC/Mac are displayed in the **[Files]** panel.
- 2 Click the folder containing the tracks you want to add to your library.
- 3 Drag and drop the selected folder to the crates panel.
A crate is created and the tracks are added to your library.

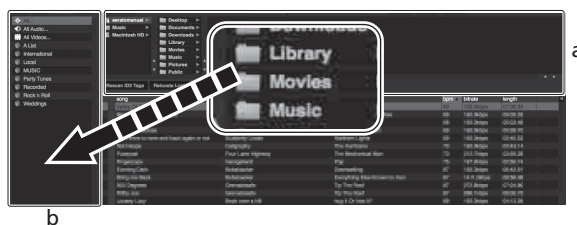

a **[Files]** panel

b Crates panel

Loading a track onto a deck

The following explains how to load a track onto deck [1] as an example.

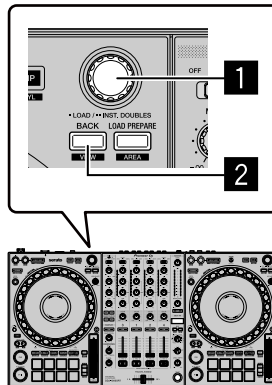

1 Rotary selector

2 BACK button

- 1 Press the **[BACK]** button on the unit, move the cursor to the crates panel, then turn the rotary selector to select the crate, etc.
- 2 Press the rotary selector, move the cursor to the library, then turn the rotary selector to select the track you want to load.



b

a Library

b Crates panel

3 Press the rotary selector.

The track loads onto deck 1.

Playing tracks

The following describes how to play the track on deck 1 (left) as an example.

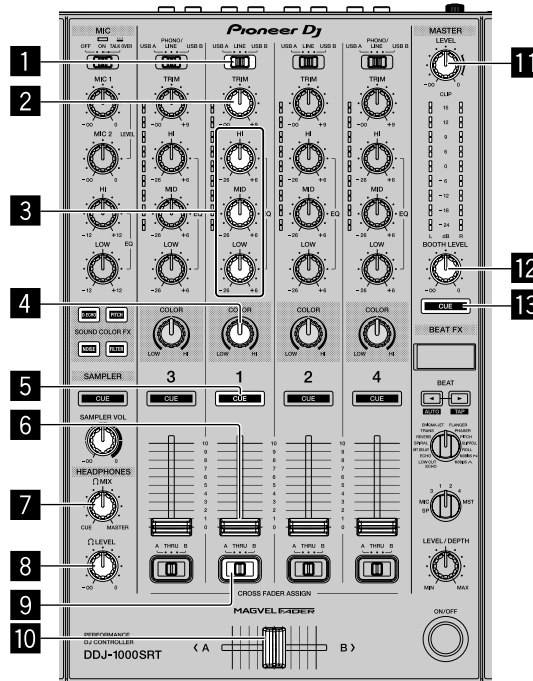

- 1** USB A, LINE, USB B switch
- 2** TRIM knob
- 3** EQ (HI, MID, LOW) knobs
- 4** COLOR knob
- 5** Headphones CUE button
- 6** Channel fader
- 7** HEADPHONES MIX knob
- 8** HEADPHONES LEVEL knob
- 9** CROSSFADER ASSIGN switch

10 Crossfader

11 MASTER LEVEL knob

12 BOOTH LEVEL knob

13 MASTER CUE button

1 Set the positions of the knobs, etc. as shown below.

- **[USB A, LINE, USB B]** switch: **[USB A]**
- **[TRIM]** knob: Turned fully counterclockwise
- **[EQ (HI, MID, LOW)]** knobs: Center
- **[COLOR]** knob: Center
- Channel fader: Bottom position
- **[MASTER LEVEL]** knob: Turned fully counterclockwise
- Crossfader: Center
- **[CROSSFADER ASSIGN]** switch: **[THRU]**

2 Press the **[PLAY/PAUSE ▶/||]** button to play the track.

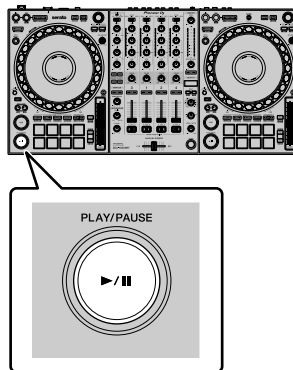

3 Turn the **[TRIM]** knob.

Adjust the **[TRIM]** knob so the channel level indicator lights up orange at the loudest part of the track.

4 Move the channel fader away from you.

- 5 Turn the **[MASTER LEVEL]** knob to adjust the volume level of the speakers.

Adjust the sound level output from the **[MASTER]** output terminals to an appropriate level.

- If you're outputting sound from the speaker of your PC/Mac, adjust the speaker volume on the PC/Mac instead of using the **[MASTER LEVEL]** knob.

Monitoring with headphones

- 1 Set the positions of knobs, etc. as shown below.
 - **[HEADPHONES MIX]** knob: Center
 - **[HEADPHONES LEVEL]** knob: Turned fully counterclockwise
- 2 Press the headphones **[CUE]** button for channel 1.
- 3 Turn the **[HEADPHONES LEVEL]** knob.
Adjust the headphones volume to a level you're happy with.

Note

This unit and the Serato DJ Pro software include a variety of features enabling characteristic DJ performances. For details on the respective features, read this manual and the Serato DJ Pro software manual.

- The Serato DJ Pro software manual can be downloaded from Serato.com. For details, see: Downloading the Serato DJ Pro software manual (page 6).

Quitting the system

- 1 Quit Serato DJ Pro.

When you close the software, a question appears on your PC/Mac screen asking for confirmation that you want to close it. Click **[Yes]** to close.

- 2 Press the **[⏻]** switch on the unit's rear panel to set the unit to standby mode.
- 3 Disconnect the USB cable from your PC/Mac.

Advanced use

Using 4 Beat Loop

During playback, press the [4 BEAT LOOP] button.

Loop playback starts with 4 beats from the point where you press the button.

- When the Quantize function is turned on, you might notice a slight delay as the loop synchronizes to the beat.

Canceling loop playback

Press the [4 BEAT LOOP] button again.

When the Loop Out point is reached, the rest of the track continues to play without returning to the Loop In point.

Using Manual Loop

You can choose the section you want to loop.

- When the Quantize function is turned on, you might notice a slight delay as the loop synchronizes to the beat.
- 1 Press the **[LOOP IN]** button at the point you want to start looping (the Loop In Point) during playback.
 - 2 Press the **[LOOP OUT]** button at the point you want the loop to end (the Loop Out Point).
The loop playback starts.

Cutting the loop

Press the [LOOP IN] button while holding the [SHIFT] button.

Each time you press the button, the loop cuts in half.

- The loop length can be cut in half even during 4 beat loop playback.

Extending the loop

Press the [LOOP OUT] button while holding the [SHIFT] button.

Each time you press the button, the loop doubles in length.

- The loop length can be doubled even during 4 beat loop playback.

Canceling a loop

Press the [4 BEAT LOOP] button.

The rest of the track continues to play without returning to the Loop In point.

Changing the Loop In point

Press the [LOOP IN] button, and turn the jog wheel.

The Loop In point is changed.

Changing the Loop Out point

Press the [LOOP OUT] button, and turn the jog wheel.

The Loop Out point is changed.

Using the Performance Pads

You can switch the functions using the respective pad mode buttons (the **[HOT CUE]** mode button, **[ROLL]** mode button, **[SLICER]** mode button and **[SAMPLER]** mode button).

Using Hot Cues

You can start playback instantly from the position where a Hot Cue is set.

- Up to 8 Hot Cue points can be set and saved for each track.

- 1 Press the **[HOT CUE]** mode button.

The unit enters Hot Cue mode.

- 2 If the track is playing or paused, press a Performance Pad to set the Hot Cue point.

The Hot Cue points are set to Performance Pads as follows:

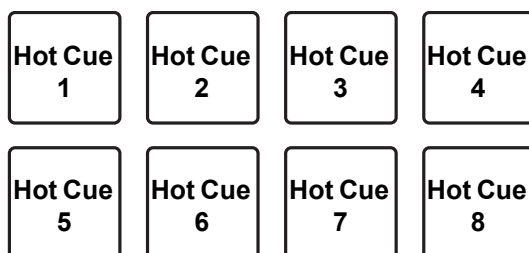

- 3 Press a Performance Pad you've set a Hot Cue for.

Playback starts from the Hot Cue point.

- You can clear Hot Cue points by pressing a Performance Pad while holding the **[SHIFT]** button.

Using Roll

When you press a Performance Pad, a loop with the number of beats assigned to the pad is set and the loop plays until you release the pad. During loop roll playback, normal playback with the original rhythm continues in the background. When a loop roll is canceled, playback resumes from the position reached in the background.

- 1 Press the **[ROLL]** mode button.
The unit enters Roll mode.
- 2 Press the **[PARAMETER◀]** or **[PARAMETER▶]** button.
The loop roll beats assigned to Performance Pad 1 through 4 switch each time you press a button.
For example, when you set a pad to “2 to 16 beats,” the pad’s setting is as shown below.



The range of beats set for the loop roll is displayed on the PC/Mac screen.



- 3 Press and hold down one of the Performance Pads.
A loop roll with the number of beats in the settings assigned to that pad is played.
Playback continues in the background during loop roll playback.
 - While holding the **[SHIFT]** button, press the **[LOOP IN]** or **[LOOP OUT]** button during loop roll to change the number of beats for the current playback loop roll.

4 Release the Performance Pad.

The loop roll is canceled, and playback resumes from the position reached in the background.

❖ Using Beat Jump

Use Performance Pad 5 through 8 during Roll mode to jump the playback position instantly without changing the original rhythm.

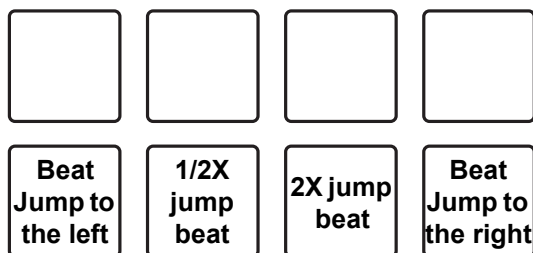

- Performance Pad 6 or 7:

The jump beat is halved or doubled.

The range of jump beats set is displayed on the PC/Mac screen.



- Performance Pad 5 or 8:

The playback position is jumped to the left or right with the jump beats set.

Using Slicer

The specified range is divided into 8 equal sections, and these 8 sliced sections are assigned to the respective Performance Pads. While you hold down a Performance Pad, the sound for the section assigned to that pad is played in a loop.

While playing a loop of the pad's sound, normal playback with the original rhythm continues in the background. When you release the Performance Pad and loop playback ends, playback resumes from the position reached at that point.

- The Slicer function can't be used with tracks for which no beatgrid is set. For details on setting beatgrids, read the Serato DJ Pro software manual.

1 Press the **[SLICER]** mode button.

The unit enters Slicer mode.

- Press the **[SLICER]** mode button while holding the **[SHIFT]** button to enter Slicer Loop mode.

➡ Read more: About Slicer mode and Slicer Loop mode (page 61)

2 Press the **[PARAMETER◀]** or **[PARAMETER▶]** button while holding the **[SHIFT]** button.

Set the domain for the Slicer function. The value set for the domain switches each time you press one of the buttons while holding the **[SHIFT]** button.

The domain can be set to one of 6 settings: 2 beats, 4 beats, 8 beats, 16 beats, 32 beats or 64 beats.

The domain is divided equally into 8 sliced sections, which are assigned to each pad as displayed below.

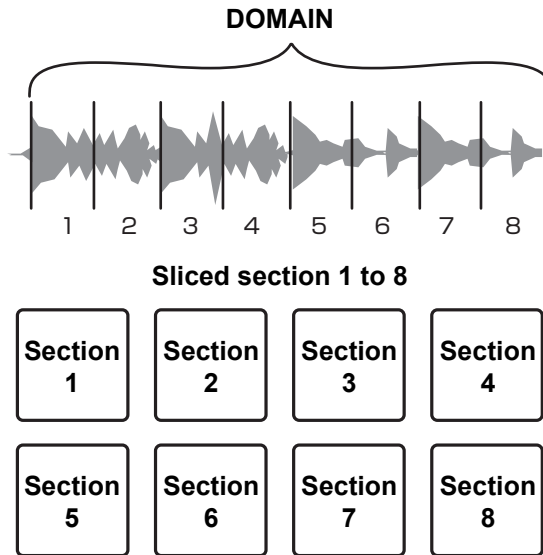

- 3 Press the **[PARAMETER◀]** or **[PARAMETER▶]** button.
 Set the quantization for the Slicer function. The value set for the quantization switches each time you press one of the buttons.
 The quantization can be set to one of 4 settings: 1/8, 1/4, 1/2 and 1.
 With the quantization setting, you can change the length of the loop which is played while holding the pad. For example, when the quantization is set to 1, the entire section assigned to the pad is played in a loop, and when the quantization is set to 1/2, only the first half of the section assigned to the pad is played in a loop.

- 4 Press and hold down a Performance Pad.
 While holding down the pad, playback continues in a loop.
 - The length of the loop differs depending on the quantization setting.
 When you release the pad, playback resumes from the position reached in the background.

❖ About Slicer mode and Slicer Loop mode

Slicer mode

When the playback position advances to the end of the range that has been sliced into 8 equal sections, the range shown on the display switches to the next 8 sliced sections, and these sliced sections are assigned to the respective pads, replacing the previously assigned sections.

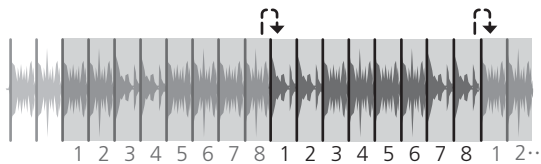

Slicer Loop mode

When the playback position advances to the end of the range that has been sliced into 8 equal sections, the playback position returns to the beginning of the range.

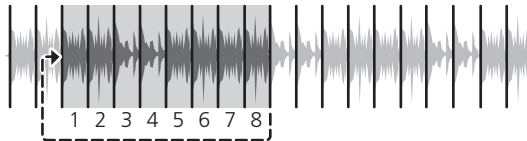

Using the Sampler

You can use the Performance Pads to play tracks or sounds assigned to the Sampler slots.

- 1 Open the **[SAMPLER]** panel.
- 2 Press the **[SAMPLER]** mode button.
The unit enters Sampler mode.
- 3 Press the **[PARAMETER◀]** or **[PARAMETER▶]** button.
Change the Sampler bank. The sampler has 4 banks, A, B, C and D, and each bank has 8 slots.
- 4 Drag and drop tracks to load them onto the **[SAMPLER]** panel's slots.
The sampler settings and loaded tracks are saved.
- 5 Press a Performance Pad.
The track or sound assigned to the relevant slot is played.
 - Playback method differs depending on the Serato DJ Pro's Sampler mode.
For details, read the Serato DJ Pro software manual.

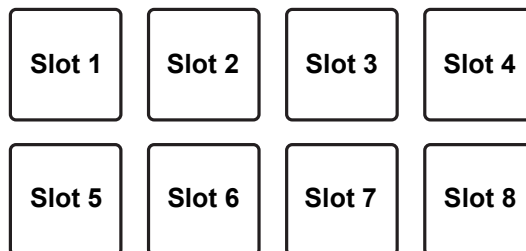

- When you press a Performance Pad while holding the **[SHIFT]** button, the sound of the slot that is currently playing stops.

Using Cue Loop

- 1 Press the **[HOT CUE]** mode button while holding the **[SHIFT]** button.

The unit enters Cue Loop mode.

- 2 Press a Performance Pad during playback.

The Loop In point is set on the Hot Cue slot and loop playback starts.

- The loop length depends on the beat number setting of Auto Loop.
The Loop In point is assigned to Performance Pads as follows.

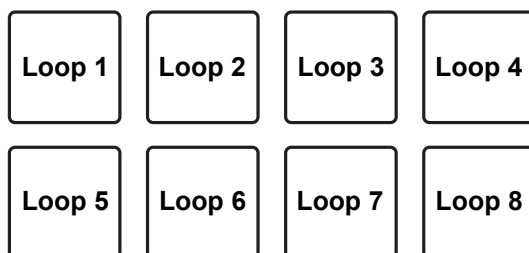

- With the Cue Loop function, the Hot Cue point is used as the Loop In point. If you press a Performance Pad at which a Hot Cue point is already set, a loop starts from that Hot Cue point.

❖ Cutting the loop

Press the [PARAMETER◀] button during loop playback.

Each time you press the button, the loop cuts in half.

- Press the **[LOOP IN]** button while holding the **[SHIFT]** button to obtain the same effect.

❖ Extending the loop

Press the [PARAMETER▶] button during loop playback.

Each time you press the button, the loop doubles in length.

- Press the **[LOOP OUT]** button while holding the **[SHIFT]** button to obtain the same effect.

❖ Returning to the Loop In point

Press the same Performance Pad while holding the [SHIFT] button.

The playback position returns to the set Loop In point and loop playback continues.

❖ Canceling a loop

Press the same Performance Pad again.

The rest of the track continues to play without returning to the Loop In point.

Using Saved Loops

You can save a loop in a loop slot of Serato DJ Pro and call up the saved loop.

- 1 Press the **[ROLL]** mode button while holding the **[SHIFT]** button.
The unit enters Saved Loop mode.
- 2 Press a Performance Pad during loop playback.
The loop is assigned to the loop slot of Serato DJ Pro.

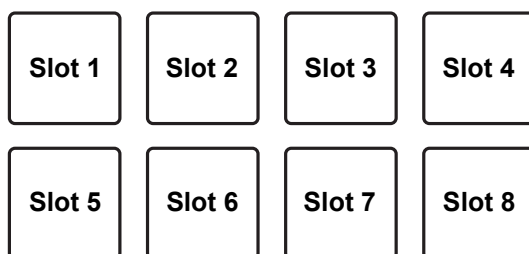

- 3 Press a Performance Pad while holding the **[SHIFT]** button.
The playback position returns to the set Loop In point and loop playback continues.

❖ Cutting the loop

Press the **[PARAMETER◀] button during loop playback.**
Each time you press the button, the loop cuts in half.

❖ Extending the loop

Press the **[PARAMETER▶] button during loop playback.**
Each time you press the button, the loop doubles in length.

❖ Returning to the Loop In point

Press the same Performance Pad while holding the [SHIFT] button.

The playback position returns to the set Loop In point and loop playback continues.

❖ Canceling a loop

Press the same Performance Pad again.

The rest of the track continues to play without returning to the Loop In point.

Using Pitch Play

To use this function, activation for the Pitch 'n Time function is required. For details, see the Pitch 'n Time DJ Activation Manual in **[Extra software information]** on the Pioneer DJ support page.
pioneerdj.com/support/

- 1 Press the **[SAMPLER]** mode button while holding the **[SHIFT]** button.
 The unit enters Pitch Play mode.
- 2 Press a Performance Pad while holding the **[SHIFT]** button to select a set Hot Cue point.
- 3 Press the Performance Pad.
 To select the pitch range to Up range, Middle range or Down range, press the **[PARAMETER◀]** button or **[PARAMETER▶]** button.
 With the pitch set on the pad you pressed, playback starts from the Hot Cue point selected in step 2.

Up range



Middle range

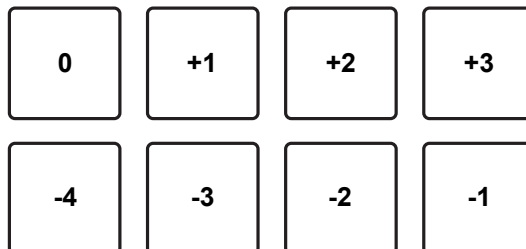

Down range

-3	-2	-1	0
-7	-6	-5	-4

Using Slip

When Slip mode is on, normal playback is continued while maintaining the original rhythm in the background during 'Scratch' play, loop playback or Hot Cue playback. When 'Scratch' play, loop playback or Hot Cue playback is canceled, normal playback resumes from the position reached at that point. Various performances are possible without breaking the rhythm.

- For the default setting, the **[SLIP]** button lights up when Slip mode is on, and flashes while playback continues in the background.

Slip Hot Cue

- 1 Press the **[HOT CUE]** mode button.
The unit enters Hot Cue mode.
- 2 Press a Performance Pad to set a Hot Cue.
- 3 Press the **[SLIP]** button.
The unit enters Slip mode.
- 4 Press and hold down a Performance Pad during playback.
Playback starts from the position where the Hot Cue is set. Playback continues while holding that pad.
Normal playback continues in the background during Hot Cue playback.
- 5 Release the Performance Pad.
Playback starts from the position reached in the background.
 - To cancel Slip mode, press the **[SLIP]** button again.

Slip Scratch Play

- 1 Make sure VINYL mode is on.
Check that the **[VINYL]** indicator on the jog display lights up.
- 2 For 'Scratch' play, operate the top of the jog wheel during playback.
Normal playback continues in the background during 'Scratch' play.
- 3 Release the top of the jog wheel.
Playback starts from the position reached in the background.
 - To cancel Slip mode, press the **[SLIP]** button again.

❖ To check if the VINYL mode is on or off

By default, VINYL mode is on, so you can 'Scratch'. You can check the current status with the lighting status of the **[VINYL]** indicator on the jog display.

To turn VINYL mode on/off, press the **[SLIP]** button while holding the **[SHIFT]** button.

Slip Braking

- 1 Adjust the **[BRAKING]** - **[Stop Time]** setting in the **[DJ Preference]** tab of the **[SETUP]** menu.

For the **[BRAKING]** setting, you can adjust the speed from the playback of the track until it stops.

When using the Slip Braking, adjust the **[Stop Time]** knob of **[BRAKING]** to around 9 o'clock to set it to stop slowly.

- 2 Press the **[SLIP]** button.

The unit enters Slip mode.

- 3 Press the **[PLAY/PAUSE ►/III]** button during playback.

Playback stops slowly. Normal playback continues in the background while slowly stopping.

- 4 Press the **[PLAY/PAUSE ►/III]** button again.

Playback starts from the position reached in the background.

- To cancel Slip mode, press the **[SLIP]** button again.

Slip Auto Loop

- 1 Press the **[SLIP]** button.

The unit enters Slip mode.

- 2 Press the **[4 BEAT LOOP]** button.

A loop with 4 beats is set at the position where you pressed the button, and loop playback starts.

Normal playback continues in the background during loop playback.

- 3 Press the **[4 BEAT LOOP]** button again.

The loop is canceled and playback starts from the position reached in the background.

- To cancel Slip mode, press the **[SLIP]** button again.

Slip Manual Loop

❖ Creating a loop in Slip mode

- 1 Press the **[SLIP]** button.
The unit enters Slip mode.
- 2 Press the **[LOOP IN]** button, then press the **[LOOP OUT]** button.
Loop playback starts.
Normal playback continues in the background during loop playback.
- 3 Press the **[4 BEAT LOOP]** button.
The loop is canceled and playback starts from the position reached in the background.
 - To cancel Slip mode, press the **[SLIP]** button again.

Using Fader Start

Using Channel Fader Start

1 Set the cue point.

Pause the track at the position you want to start playback from, then press the **[CUE]** button on that deck.

- You can also set the cue point by moving the channel fader from the top to the bottom while holding the **[SHIFT]** button during a pause.

2 While holding the **[SHIFT]** button, move the channel fader from the bottom to the top.

Playback starts from the cue point.

- If you move the channel fader back to the bottom while holding the **[SHIFT]** button during playback, the track instantly jumps back to the cue point and playback pauses. (Back Cue)

When no cue point is set, playback starts from the beginning of the track.

When you move the channel fader from the top to the bottom and hold the **[SHIFT]** button while triggering a cue, playback of the track starts from the set cue point.

Using Crossfader Start

If you want to use Crossfader Start, set the **[CROSSFADER ASSIGN]** switch to **[A]** or **[B]**, the channel you want to move.

1 Set the cue point.

Pause the track at the position you want to start playback from, then press the **[CUE]** button on that deck.

- You can also set the cue point by moving the crossfader to the left edge or the right edge while holding the **[SHIFT]** button during a pause.

2 Move the crossfader to the left edge or right edge.

If you want to use Crossfader Start to trigger playback on channel 2, set the crossfader to the left edge, and vice versa.

3 Hold the **[SHIFT]** button and move the crossfader towards the opposite edge from where it's set.

Playback of the track starts from the cue point.

- If you hold the **[SHIFT]** button during playback and move the crossfader back to the edge where you started from, the playback position instantly jumps back to the cue point and pauses. (Back Cue)

When no cue point is set, playback starts from the beginning of the track.

When moving the crossfader from the left edge to right edge (or vice versa) and holding the **[SHIFT]** button while triggering a cue, playback of the track starts from the set cue point.

Using effects

The unit is equipped with two types of effects, BEAT FX and SOUND COLOR FX.

Using BEAT FX

You can instantly set various effects that match the tempo (BPM = Beats Per Minute) of the currently playing track.

BEAT FX display on the unit



1 Effect name

Displays the name of the selected effect.

2 AUTO / TAP

When the BPM measurement mode is auto mode, **[AUTO]** is displayed. When it's manual input mode, **[TAP]** is displayed.

3 BPM value

Displays the automatically detected BPM in auto mode.

If the BPM cannot be detected, the previously detected BPM value flashes.

Displays the manually input BPM in manual input mode.

4 Beat / parameter

Displays the selected number of beats.

Displays parameters depending on an effect when you press the **[BEAT ◀, ▶]** buttons.

5 Selected channel

Displays the channel to which the effect is to be applied. Displays **[SP]** (Sampler), **[MIC]**, **[CH 1]**, **[CH 2]**, **[CH 3]**, **[CH 4]**, or **[MST]** (Master) according to the selected channel.

- 1 Press the **[BEAT ◀]** button or **[BEAT ▶]** button while holding the **[SHIFT]** button.

Select the BPM measurement mode.

- **[AUTO]**: Press the **[BEAT ◀]** button while holding the **[SHIFT]** button. The BPM is automatically measured from the input audio signal.
- **[TAP]**: Press the **[BEAT ◀]** button while holding the **[SHIFT]** button. Enter the BPM manually. For details, read: Inputting the BPM manually (page 78).
- The BPM measurement range for the **[AUTO]** setting is 70 to 180. BPM may not be correctly measured for some tracks. If the BPM can't be measured, the BPM value on the display flashes. In such cases, use the **[TAP]** button to input the BPM manually.

- 2 Rotate the **[BEAT FX SELECT]** knob.

Selects a type of effect.

- For details, see: Types of BEAT FX (page 79).

- 3 Rotate the **[BEAT FX CH SELECT]** knob.

Selects a channel to apply the effect to.

- Set **[Sampler Player Output Select]** to **[A]** on Serato DJ Pro.
- **[SP]**: Applies the effect to the sound of **[SAMPLER]**.
- **[MIC]**: Applies the effect to the sound of the **[MIC]** channel.
- **[1]** to **[4]**: Applies the effect to the sound of the respective channel.
- **[MST]**: Applies the effect to the sound of the **[MASTER]** channel.

- 4 Press the **[BEAT ◀]** button or **[BEAT ▶]** button.

Increases or decreases the effect timing.

The effect time corresponding to the selected length is set automatically.

5 Press the **[BEAT FX ON/OFF]** button.

The effect is applied to the sound.

You can adjust the effect's parameter by turning the **[BEAT FX LEVEL/DEPTH]** knob.

The **[ON/OFF]** button flashes when the effect is on.

- Press the **[ON/OFF]** button again to turn the effect off.

Inputting the BPM manually

While holding the **[SHIFT]** button, tap the **[BEAT ►]** button more than twice with your finger in time with the beat of the sound being played. The average value of the interval that the button is tapped is displayed in the BPM indicator of the jog display.

- To return to auto mode, press the **[BEAT ◀]** button while holding the **[SHIFT]** button.

Types of BEAT FX

LOW CUT ECHO

Low Cut Echo cuts out the low frequencies (bass) and only echoes the higher frequencies according to the beat you set with the **[BEAT ◀, ▶]** buttons.

- When you move the channel fader to the bottom to cut the input volume, echo sound remains (echo tail) and the sound is faded out.

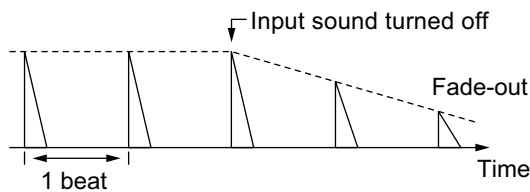

- **[BEAT ◀, ▶]** buttons
Sets the delay time between 1/16 and 16 beats with respect to 1 beat of BPM time.
- **[LEVEL/DEPTH]** knob
Sets the balance between the original sound and the echo sound.

When you select an effect channel from **[1]** to **[4]** of the effect channel selector switch, the effect sound can't be monitored even if you press the **[CUE]** button of the selected channel.

ECHO

Echoes according to the beat you set with the **[BEAT ◀, ▶]** buttons.

- When you move the channel fader to the bottom to cut the input volume, echo sound remains (echo tail) and the sound is faded out.

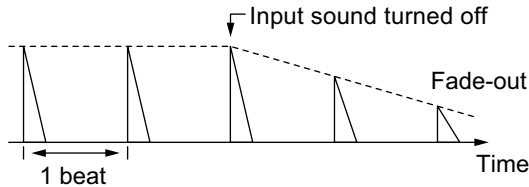

- **[BEAT ◀, ▶]** buttons
Sets the delay time between 1/16 and 16 beats with respect to 1 beat of BPM time.
- **[LEVEL/DEPTH]** knob
Sets the balance between the original sound and the echo sound.

When you select an effect channel from **[1]** to **[4]** of the effect channel selector switch, the effect sound can't be monitored even if you press the **[CUE]** button of the selected channel.

MULTI TAP DELAY

A delayed sound comes out up to 7 times in $1/8$ beat intervals according to the beat you set with the **[BEAT ◀, ▶]** buttons.

- When you move the channel fader to the bottom to cut the input volume, the delayed sound remains.

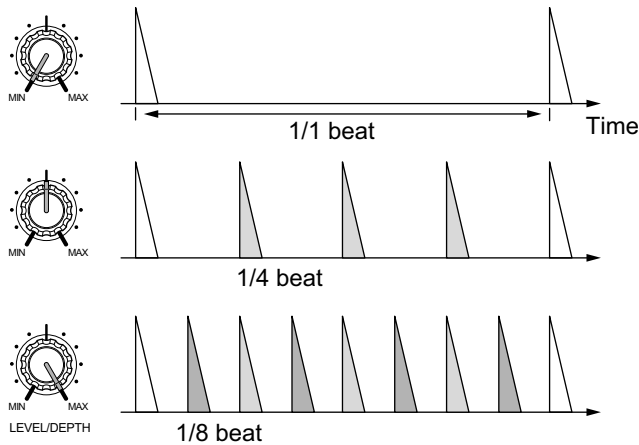

- **[BEAT ◀, ▶]** buttons
Sets the effect time between $1/16$ and 16 beats with respect to 1 beat of BPM time.
- **[LEVEL/DEPTH]** knob
Sets the volume of an odd-number delay from the **[MIN]** position to the center position, and an even-number delay from the center position to the **[MAX]** position.

When you select an effect channel from **[1]** to **[4]** of the effect channel selector switch, the effect sound can't be monitored even if you press the **[CUE]** button of the selected channel.

SPIRAL

A reverberation effect is applied to the input sound.

The pitch changes at the same time if the delay time is changed.

- When you move the channel fader to the bottom to cut the input volume, the effect sound remains.

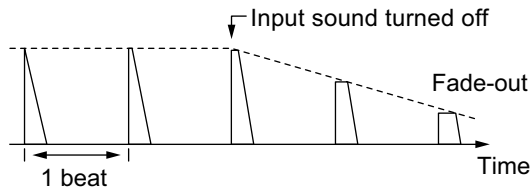

- **[BEAT ◀, ▶]** buttons
Sets the delay time between 1/16 and 16 beats with respect to 1 beat of BPM time.
- **[LEVEL/DEPTH]** knob
Sets feedback, and the balance between the original sound and the effect sound.

When you select an effect channel from **[1]** to **[4]** of the effect channel selector switch, the effect sound can't be monitored even if you press the **[CUE]** button of the selected channel.

REVERB

A reverberation effect is applied to the input sound.

- When you move the channel fader to the bottom to cut the input volume, the reverberation sound remains.

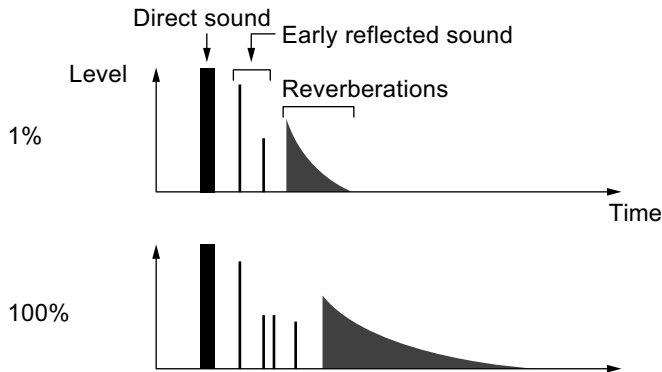

- **[BEAT ◀, ▶]** buttons
Sets the extent of the reverberation effect between 1 and 100%.
- **[LEVEL/DEPTH]** knob
Sets the balance between the original sound and the echo sound.

When you select an effect channel from **[1]** to **[4]** of the effect channel selector switch, the effect sound can't be monitored even if you press the **[CUE]** button of the selected channel.

TRANS

The sound is cut according to the beat you set with the **[BEAT ◀, ▶]** buttons.

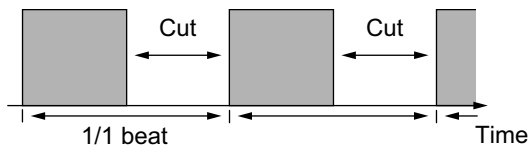

- **[BEAT ◀, ▶]** buttons
Sets the cut time between 1/16 and 16 beats with respect to 1 beat of BPM time.
- **[LEVEL/DEPTH]** knob
Sets the balance and duty ratio between the original sound and effect sound.

ENIGMA JET

According to the beat you set with the **[BEAT ◀, ▶]** buttons, a Flanger effect is produced, adding sound with a feeling of infinite rising or descending.

- **[BEAT ◀, ▶]** buttons
Sets the beat fraction between 1/16 and 64 beats or between -64 and -1/16 beats, with respect to 1 beat of BPM time. The pitch ascends for beat fractions between 1/16 and 64 beats. The pitch descends for beat fractions between -64 and -1/16.
- **[LEVEL/DEPTH]** knob
The further clockwise the control is turned, the greater the effect is stressed.
When turned all the way counterclockwise, only the original sound comes out.

FLANGER

One cycle Flanger effect is produced according to the beat you set with the **[BEAT ◀, ▶]** buttons.

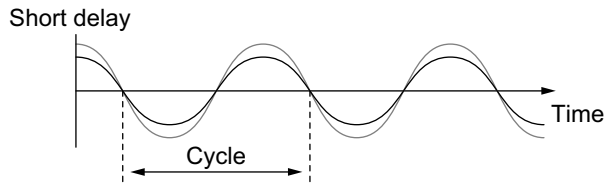

- **[BEAT ◀, ▶]** buttons

Sets the effect time between 1/16 and 64 beats with respect to 1 beat of BPM time.

- **[LEVEL/DEPTH]** knob

The further clockwise the control is turned, the greater the effect is stressed.

When turned all the way counterclockwise, only the original sound is output.

PHASER

The Phaser effect changes according to the beat you set with the **[BEAT ◀, ▶]** buttons.

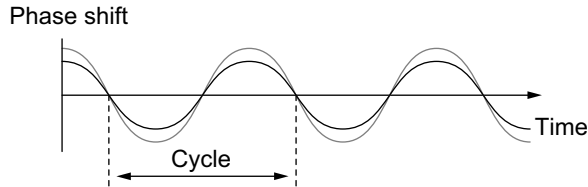

The phaser effect changes according to the set beat button.

- **[BEAT ◀, ▶]** buttons
Sets the cycle for moving the Phaser effect with respect to 1 beat of BPM between 1/16 and 64 beats.
- **[LEVEL/DEPTH]** knob
The further clockwise the control is turned, the greater the effect is stressed.
When turned all the way counterclockwise, only the original sound is output.

PITCH

Changes the pitch of the original sound.

- **[BEAT ◀, ▶]** buttons
Sets the pitch of the effect sound between -50 and 100%.
- **[LEVEL/DEPTH]** knob
Sets the pitch of the effect sound.
When you turn the knob all the way counterclockwise, the setting returns to the pitch of the original sound.

SLIP ROLL

The sound being input at the point when you press the **[ON/OFF]** button is recorded, and the recorded sound comes out repeatedly according to the beat you set with the **[BEAT ◀, ▶]** buttons. When the effect time changes, the input sound is recorded again.

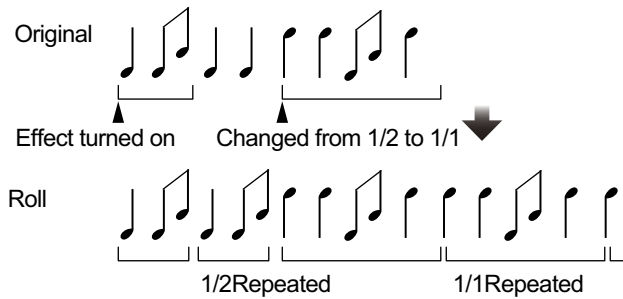

- **[BEAT ◀, ▶]** buttons
Sets the effect time between 1/16 and 16 beats with respect to 1 beat of BPM time.
- **[LEVEL/DEPTH]** knob
Sets the balance between the original sound and Roll sound.

ROLL

The sound being input at the point when you press the **[ON/OFF]** button is recorded, and the recorded sound comes out repeatedly according to the beat you set with the **[BEAT ◀, ▶]** buttons.

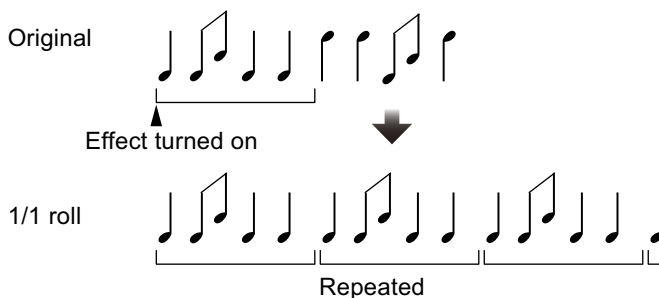

- **[BEAT ◀, ▶]** buttons
Sets the effect time between 1/16 and 16 beats with respect to 1 beat of BPM time.
 - **[LEVEL/DEPTH]** knob
Sets the balance between the original sound and Roll sound.
-

MOBIUS ∩ (SAW)

According to the beat you set with the **[BEAT ◀, ▶]** buttons, saw-tooth wave is produced, adding sound with a feeling of infinite rising or descending.

This sound is mixed with the input sound, and the resulting sound comes out. Oscillation is possible even if sound isn't input.

- **[BEAT ◀, ▶]** buttons
Sets the beat fraction between 1/16 and 64 beats or between -64 and -1/16 beats, with respect to 1 beat of BPM time. The pitch ascends for beat fractions between 1/16 and 64 beats. The pitch descends for beat fractions between -64 and -1/16.
 - **[LEVEL/DEPTH]** knob
Adjusts the volume of the sawtooth wave sound to be mixed.
-

MOBIUS ∧ (TRI)

According to the beat you set with the **[BEAT ◀, ▶]** buttons, triangular wave is produced, adding sound with a feeling of infinite rising or descending.

This sound is mixed with the input sound, and the resulting sound comes out. Oscillation is possible even if sound isn't input.

- **[BEAT ◀, ▶]** buttons:
Sets the beat fraction between 1/16 and 64 beats or between -64 and -1/16 beats, with respect to 1 beat of BPM time. The pitch ascends for beat fractions between 1/16 and 64 beats. The pitch descends for beat fractions between -64 and -1/16.

- **[LEVEL/DEPTH]** knob:
Adjusts the volume of the triangular wave sound to be mixed.

Using **SOUND COLOR FX**

These effects change in association with the **[COLOR]** knobs for each channel.

- 1 Press one of **[SOUND COLOR FX SELECT]** buttons.
Select an effect type.
The pressed button flashes.
 - If you already selected one button and then pressed another, the newly pressed button is selected.
 - The same effect is set for all channels.
- 2 Turn a **[COLOR]** knob.
The effect is applied to the channel for which the knob is turned.

Canceling **SOUND COLOR FX**

Press the flashing **[SOUND COLOR FX SELECT]** button.
The effect is canceled.

Types of SOUND COLOR FX

The unit has 4 types of SOUND COLOR FX.

DUB ECHO

Outputs delayed sounds repeatedly and gradually attenuate it, giving an echo effect. The effect sound can't be monitored even if you press the **[CUE]** button of the selected channel.

[COLOR] knob:

- Turn counterclockwise: Applies the echo effect to the mid-range only.
- Turn clockwise: Applies the echo effect to the high-range only.

PITCH

Changes the sound pitch.

[COLOR] knob:

- Turn counterclockwise: The pitch descends.
- Turn clockwise: The pitch rises.

NOISE

White noise generated inside the unit is mixed in to the sound of the channel via the filter and output.

[COLOR] knob:

- Turn counterclockwise: Gradually decreases the cut-off frequency of the filter through which the white noise passes.
- Turn clockwise: Gradually increases the cut-off frequency of the filter through which the white noise passes. Turn the **[TRIM]** knob of each channel to adjust the volume when using **[NOISE]**.

FILTER

Outputs sound that has passed through a filter.

[COLOR] knob:

- Turn counterclockwise: Gradually decreases the low-pass filter's cut-off frequency.

- Turn clockwise: Gradually increases the high-pass filter's cut-off frequency.

Using a microphone

- 1 Connect a microphone to the **[MIC1]** input terminal or **[MIC2]** input terminal.
- 2 Set the **[OFF, ON, TALK OVER]** switch to **[ON]** or **[TALK OVER]**.
 - **[ON]**: The indicator lights up.
 - **[TALK OVER]**: The indicator flashes.
 - When you set the switch to **[TALK OVER]**, the sound of channels other than the **[MIC1]** channel and **[MIC2]** channel is attenuated by -18 dB (default) when a sound of -10 dB or greater is input to the microphone.
 - The level of attenuation applied when you set the switch to **[TALK OVER]** can be changed in Utilities mode. For details on how to change this setting, read: MIC TALKOVER level setting (page 99).
 - Talkover mode can be switched between Normal mode and Advanced mode. For details on how to change this setting, read: MIC TALKOVER mode setting (page 99).
- 3 Turn the **[MIC1 LEVEL]** knob or **[MIC2 LEVEL]** knob.
Adjust the volume of the sound output from the **[MIC1]** channel or **[MIC2]** channel.
 - The sound comes out at a loud volume if the knob is turned all the way to the right.
- 4 Input audio to the microphone.

Adjusting the sound quality

Turn the **[EQ (HI, LOW)]** knobs.

- **[HI]**: -12 dB to +12 dB (10 kHz)
- **[LOW]**: -12 dB to +12 dB (100 Hz)

Using external inputs

The unit has four sets of external inputs to connect CD players, turntables, etc. The '4-CHANNEL MIXER' of the unit can be used to mix input sound without passing through your PC/Mac. The following mixer features can be used even when not connected to a PC/Mac.

Note

- For details on the respective items, read: Connecting (page 42) and Part names and functions (page 15).

Mixing the sound of a DJ player, etc.

- 1 Connect a DJ player or other line level output device to the **[LINE]** input terminal or the **[LINE/PHONO]** input terminal.
- 2 Set the **[LINE/PHONO]** switch on the rear panel of the unit to **[LINE]**.
- 3 Set the **[USB A, LINE, USB B]** switch or **[USB A, PHONO/LINE, USB B]** switch on the top panel of the unit to **[LINE]** or **[PHONO/LINE]**.
- 4 Turn the **[TRIM]** knob and move the channel fader to adjust the volume of the sound output from each channel.

Mixing the sound of turntables, etc.

- 1 Connect turntables or other phono level (for MM cartridges) output devices to the **[LINE/PHONO]** input terminals of **[CH3]** or **[CH4]**.
 - **[CH1]** and **[CH2]** are input terminals for **[LINE]** only.
 - Connect the ground wire of the turntable to the **[SIGNAL GND]** terminal of the unit.
- 2 Set the **[LINE/PHONO]** switch on the rear panel of the unit to **[PHONO]**.
- 3 Set the **[USB A, PHONO/LINE, USB B]** switch on the top panel of the unit to **[PHONO/LINE]**.
- 4 Turn the **[TRIM]** knob and move the channel fader to adjust the volume of the sound output from each channel.

Changing the settings

Launching Utilities mode

If Utilities mode is launched while the unit is connected to your PC/Mac using the USB cable, the set status may not be displayed properly.

- 1 Disconnect the USB cable from your PC/Mac.
- 2 Press the **[⏻]** switch on the rear panel of the unit to turn the unit to Standby mode.
- 3 Hold both the **[SHIFT]** and **[PLAY/PAUSE ▶/⏸]** buttons on the left deck and press the **[⏻]** switch.
Utilities mode launches.
- 4 Press the **[BEAT ◀, ▶]** buttons.
Select the setting item.
- 5 Press the **[MASTER CUE]** button.
The screen is changed to select the setting value of the selected setting item.
- 6 Press the **[BEAT ◀, ▶]** buttons.
Select the setting value.
- 7 Press the **[MASTER CUE]** button.
The setting value is determined.
The screen is changed to the previous screen.
- 8 Press the **[⏻]** switch to turn the unit to standby.
Settings are saved and Utilities mode ends.

Utilities modes

The following settings can be changed:

- MIDI controller mode setting (page 96)
- Demo/Screen Saver setting (page 97)
- Auto Standby setting (page 98)
- MIC TALKOVER mode setting (page 99)
- MIC TALKOVER level setting (page 99)
- MIC LOW CUT FILTER setting (page 100)
- Microphone output setting for the Booth monitor (page 100)
- Microphone sound limiter setting to be added to the Master output (page 101)
- Microphone sound limiter setting to be added to the Booth output (page 101)
- Master Attenuator Level setting (page 101)
- Mono/stereo setting for the Master output (page 102)
- Booth Attenuator Level setting (page 102)
- Mono/stereo setting for the Booth output (page 102)
- Peak Limiter setting for the Master output (page 103)
- REC OUT setting (page 103)
- Channel Fader Start setting (page 104)
- Crossfader Start setting (page 104)
- Crossfader Cut Lag setting (page 105)
- Slip mode flashing setting (page 105)
- [SLIP] button lit/flash operation setting (page 106)
- Jog ring brightness setting (page 106)
- Jog display brightness setting (page 106)
- BEAT FX display brightness setting (page 107)
- Factory resetting (page 107)

MIDI controller mode setting

The unit changes operation according to whether Serato DJ Pro is running.

Setting item: **[MIDI MODE]**

- **[AUTO]**

When Serato DJ Pro is running, the unit can be used as a controller suitable for the Serato DJ Pro features.

When Serato DJ Pro isn't running, the unit can be used as a general MIDI controller.

- **[GENERAL]**

Even though Serato DJ Pro is running, the unit is used as a general MIDI controller.

Default setting is **[AUTO]**.

Demo/Screen Saver setting

Set the Screen Saver and the time for when to start Demo mode. To cancel Demo mode or Screen Saver, operate any knob or button on the unit.

Setting item: **[DEMO / S.SAVER]**

- **[DISABLE]**

Demo mode and the Screen Saver feature don't start.

- **[DEMO 1min]**

Demo mode starts when there is no operation on the unit for 1 minute.

- **[DEMO 5min]**

Demo mode starts when there is no operation on the unit for 5 minutes.

- **[DEMO 10min]**

Demo mode starts when there is no operation on the unit for 10 minutes.

- **[S.SAVER]**

The Screen Saver starts when there is no operation on the unit for 30 minutes.

Default setting is **[DEMO 10min]**.

Auto Standby setting

Change the Auto Standby setting.

When this setting is enabled, the unit enters Standby mode automatically after 4 hours if the following conditions are met.

- None of the unit's buttons or knobs are operated.
- No audio signal of –24 dB or greater is input to an input terminal of the unit.

Press the **[QUANTIZE]** button on the left deck to cancel Standby mode.

Setting item: **[AUTO STANDBY]**

- **[ON]**

The Auto Standby feature is enabled.

- **[OFF]**

The Auto Standby feature is disabled.

Default setting is **[ON]**.

MIC TALKOVER mode setting

Switch Talkover mode.

Setting item: **[TALKOVER MODE]**

- **[ADVANCED]**

Sound from channels other than the microphone channel comes out with only the mid-range attenuated according to the talkover level setting.

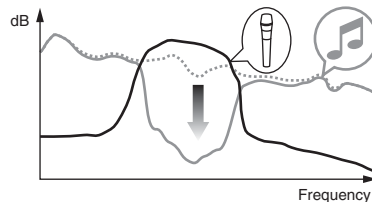

- **[NORMAL]**

Sound from channels other than the microphone channel comes out with the sound attenuated according to the talkover level setting.

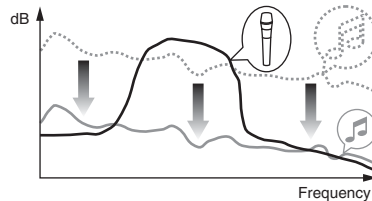

Default setting is **[ADVANCED]**.

MIC TALKOVER level setting

Set the Talkover feature's sound attenuation level.

Setting item: **[TALKOVER LEVEL]**

Setting values: **[-6 dB] / [-12 dB] / [-18 dB] / [-24 dB]**

Default setting is **[-18 dB]**.

MIC LOW CUT FILTER setting

Set whether to apply a filter to microphone sound to cut out sound lower than the human voice.

Background noise from the speaker, etc. input to the microphone can be reduced by the low cut filter.

Setting item: **[MIC LOW CUT]**

- **[ON]:**
MIC LOW CUT FILTER is enabled.
- **[OFF]:**
MIC LOW CUT FILTER is disabled.

Default setting is **[ON]**.

Microphone output setting for the Booth monitor

Change whether or not the microphone sound comes out from the booth channel.

Setting item: **[MIC TO BOOTH]**

- **[ON]**
The microphone sound comes out to the booth channel.
- **[OFF]**
The microphone sound doesn't come out to the booth channel.

Default setting is **[ON]**.

Microphone sound limiter setting to be added to the Master output

Decreases sudden, unpleasant digital clipping of microphone sound that is added to the master output.

Setting item: **[MIC LMT (MSTR)]**

- **[ON]**
Enable the peak limiter.
- **[OFF]**
Disable the peak limiter.

Default setting is **[ON]**.

Microphone sound limiter setting to be added to the Booth output

Decreases sudden, unpleasant digital clipping of microphone sound that is added to the booth output.

Setting item: **[MIC LMT (BOOTH)]**

- **[ON]**
Enable the peak limiter.
- **[OFF]**
Disable the peak limiter.

Default setting is **[ON]**.

Master Attenuator Level setting

Set the master output attenuator level.

Setting item: **[MASTER ATT.]**

Setting values: **[0 dB] / [-6 dB] / [-12 dB]**

Default setting is **[0 dB]**.

Mono/stereo setting for the Master output

Switch the mono/stereo setting for the master output sound.

Setting item: **[MASTER OUT]**

- **[MONO]**

The master sound is output in mono.

- **[STEREO]**

The master sound is output in stereo.

Default setting is **[STEREO]**.

Booth Attenuator Level setting

Set the booth output attenuator level.

Setting item: **[BOOTH ATT.]**

Setting values: **[0 dB] / [-6 dB] / [-12 dB]**

Default setting is **[0 dB]**.

Mono/stereo setting for the Booth output

Switch the mono/stereo setting for the booth output sound.

Setting item: **[BOOTH OUT]**

- **[MONO]**

The booth sound is output in mono.

- **[STEREO]**

The booth sound is output in stereo.

Default setting is **[STEREO]**.

Peak Limiter setting for the Master output

Decreases sudden, unpleasant digital clipping of the master output.

Setting item: **[MASTER LIMITER]**

- **[ON]**

Enable the peak limiter.

- **[OFF]**

Disable the peak limiter.

Default setting is **[ON]**.

REC OUT setting

Set whether to output microphone sound to the REC output from the unit.

Setting item: **[REC OUT]**

- **[WITH MIC]**

The microphone sound can be output to the REC output.

- **[WITHOUT MIC]**

The microphone sound can't be output to the REC output.

Default setting is **[WITH MIC]**.

Channel Fader Start setting

Change the setting of the Channel Fader Start feature.

Setting item: **[CH FDR START]**

- **[ON(SYNC ON)]**

The Channel Fader Start feature is enabled with the Sync feature. (The Sync feature is activated when the Channel Fader Start feature starts.)

- **[ON(SYNC OFF)]**

The Channel Fader Start feature is enabled without the Sync feature. (The Sync feature isn't activated when the Channel Fader Start feature starts.)

- **[OFF]:**

The Channel Fader Start feature is disabled.

Default setting is **[ON(SYNC OFF)]**.

Crossfader Start setting

Change the setting for the Crossfader Start feature.

Setting item: **[CR FDR START]**

- **[ON(SYNC ON)]**

The Crossfader Start feature is enabled with the Sync feature. (The Sync feature is activated when the Crossfader Start feature starts.)

- **[ON(SYNC OFF)]**

The Crossfader Start feature is enabled without the Sync feature. (The Sync feature isn't activated when the Crossfader Start feature starts.)

- **[OFF]:**

The Crossfader Start feature is disabled.

Default setting is **[ON(SYNC OFF)]**.

Crossfader Cut Lag setting

Adjust the cut lag (range of no sound) on both edges of the crossfader.

The setting value is the size of the cut lag.

Setting item: **[CR FDR CUT LAG]**

Setting values: **[0]** to **[52]**

Default setting is **[7]**.

Slip mode flashing setting

When Slip mode is on, the buttons that can be operated in Slip mode (**[4 BEAT LOOP]** button, **[PLAY/PAUSE ►/II]** button, etc.) will flash.

This setting can be used to disable the flashing of these buttons.

Setting item: **[SLIP FLASHING]**

- **[ENABLE]**

Slip mode flashing is enabled.

- **[DISABLE]**

Slip mode flashing is disabled.

Default setting is **[ENABLE]**.

[SLIP] button lit/flash operation setting

By default, the **[SLIP]** button lights when the mode switches to Slip mode and flashes while playback is continuing in the background. With this setting, the **[SLIP]** button can be made to flash when Slip mode is started, regardless of whether or not normal playback continues while the original rhythm is maintained in the background. Setting item: **[SLIP LIT TYPE]**

- **[LIT]**

The **[SLIP]** button lights upon entering Slip mode and the **[SLIP]** button flashes while normal playback is continued while the original rhythm is maintained in the background.

- **[BLINK]**

The **[SLIP]** button flashes upon entering Slip mode.

Default setting is **[LIT]**.

Jog ring brightness setting

Set the brightness of the jog ring illumination.

Set to **[1]** for the darkest illumination and **[3]** for the brightest illumination.

Setting item: **[JOG RING BRT.]**

Setting values: **[OFF] / [1] / [2] / [3]**

Default setting is **[3]**.

Jog display brightness setting

Set the brightness of the jog display.

Set to **[1]** for the darkest illumination and **[5]** for the brightest illumination.

Setting item: **[JOG DISP. BRT.]**

Setting values: **[1] / [2] / [3] / [4] / [5]**

Default setting is **[5]**.

BEAT FX display brightness setting

Sets the brightness of the BEAT FX display.

Set to **[1]** for the darkest illumination, and **[3]** for the brightest illumination.

Setting item: **[DISPLAY BRT.]**

Setting values: **[1] / [2] / [3]**

Default setting is **[3]**.

Factory resetting

All settings will be changed to defaults.

Setting item: **[FACTORY RESET]**

- **[cancel]:**

Don't change settings to defaults.

- **[reset]:**

Change settings to defaults.

Select the item and press the **[MASTER CUE]** button to complete resetting.

Setting utility software

You can use the setting utility to perform the checks and settings described below.

- Adjusting the buffer size (when ASIO is used) (page 109)
- Checking the version of the driver software (page 110)

Displaying the setting utility

For Mac

In Finder, open the **[Applications]** folder, then click the **[Pioneer] > [DDJ-1000SRT] > [DDJ-1000SRT driver version display utility]**.

For Windows 10

In the **[Start]** menu, click **[Pioneer] > [DDJ-1000SRT Settings Utility]**.

For Windows 8.1

In **[Apps view]**, click **[Pioneer] > [DDJ-1000SRT Settings Utility]**.

For Windows 7

In the Windows **[Start]** menu, click **[All Programs] > [Pioneer] > [DDJ-1000SRT] > [DDJ-1000SRT Settings Utility]**.

Adjusting the buffer size (when ASIO is used)

You can use this feature only with a Windows operating system. If an application using the unit as the default audio device (DJ software, etc.) is running, quit the application before adjusting the buffer size. Display the setting utility before starting.

Click the [ASIO] tab.

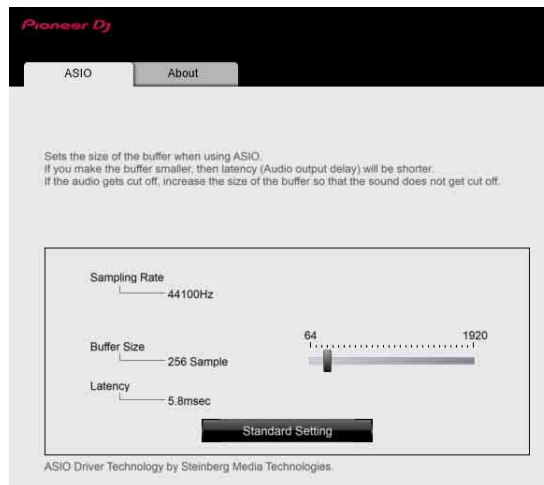

- If a large buffer size is set, drops in audio data (breaks in the sound) occur less easily, but the time lag due to the delay in the transfer of the audio data (latency) increases.

Checking the version of the driver software

Display the setting utility before starting.

Click the **[About]** tab.

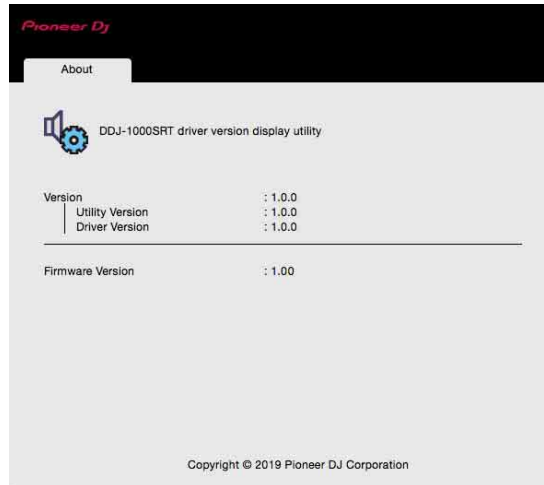

- You can check the firmware version of the unit on the screen.
- The firmware version isn't displayed when the unit isn't connected to the PC or when the unit and PC aren't properly communicating.

Setting Crossfader Curve

The Crossfader Curve setting is available in the **[SETUP]** menu of Serato DJ Pro.

- 1 Press the **[SETUP]** button on Serato DJ Pro to display the **[SETUP]** menu.
- 2 Select the **[Mixer]** tab in the **[SETUP]** menu.
- 3 Adjust **[Curve]** of **[CROSSFADER]**.
You can adjust the curve characteristic of the crossfader.
 - When turning to **[SLOW]**, the curve slowly rises.
 - When turning to **[FAST]**, the curve quickly rises.

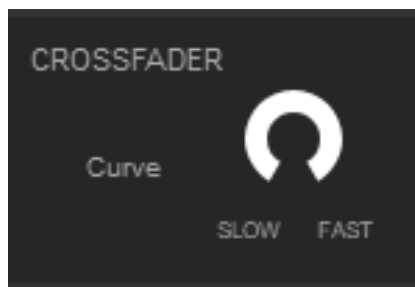

Additional information

Troubleshooting

If you think something is wrong with the unit, check the information below and refer to the **[FAQ]** for the DDJ-1000SRT on the Pioneer DJ website.

pioneerdj.com/support/

Also, check any connected devices. If you can't solve the problem, ask your nearest Pioneer authorized service center or your dealer to carry out repair work.

- The unit may not work properly if it's subjected to static electricity or other external influences. In this case, you may be able to restore proper operation by turning off the power, waiting 1 minute, then turning the power back on.

Power

❖ The unit doesn't power up.

- See: Connecting (page 42).
- Press the **[⏻]** switch on the rear panel of the unit to turn on the unit.

Connection

❖ **The unit isn't recognized by your PC/Mac.**

- Connect the supplied USB cable correctly. See: Connecting input terminals (page 38).
- If you're using a USB hub, disconnect it.
- If another USB device is connected to your PC/Mac, disconnect it.
- Set the driver software properly. (page 7)
- Quit any other open applications including screen savers and resident software on your PC/Mac. (When quitting antivirus security software, before doing so, disable the Internet connection to ensure the security of your PC/Mac.)
- If multiple ASIO drivers other than this unit are installed on your PC/Mac, uninstall unnecessary ASIO drivers.
- Check if the unit's firmware version can be displayed in the setting utility. (page 110)

Sound

- ❖ **Sound isn't output, is too small or is distorted.**
 - Set the **[TRIM]** knob, **[MASTER LEVEL]** knob, **[LINE/PHONO]** switch and **[USB A, PHONO/LINE, USB B]** switch (or **[USB A, LINE, USB B]** switch) to the correct position. (page 28, 34, 49)
 - Connect the connection cable properly. (page 38)
 - Clean the terminals and plugs before connecting them to the unit.
 - On a Windows operating system, use the setting utility to set an appropriate buffer size value. (page 109)
 - On a Mac, set the appropriate buffer size (latency) value for the DJ software.

- ❖ **Microphone sound can't be output.**
 - Set the **[OFF, ON, TALK OVER]** switch to the correct position. (page 91)

- ❖ **Sound from the Sampler deck can't be monitored on the headphones.**
 - If **[SAMPLER CUE]** isn't selected, press the **[SAMPLER CUE]** button to turn on the monitor of the Sampler deck.
 - Set the **[SAMPLER VOL]** knob to the correct position.
 - Set **[Sampler Player Output Select]** to **[A]** on Serato DJ Pro.

Serato DJ Pro

❖ Serato DJ Pro becomes unstable.

- Update the Serato DJ Pro to the latest version. See: Installing the software (page 7)
- Quit any other open applications on your PC/Mac. If operation remains unstable, try disabling the wireless network or other wireless connections, antivirus software, screen saver, low power mode, etc.
- If another USB device is connected to your PC/Mac, disconnect it.
- If you're using a USB hub, disconnect it.
- If you're using battery power for your laptop, connect the laptop to an AC power supply.

❖ Tracks aren't displayed in the library.

- Import music files. For details about importing music files, see the Serato DJ Pro software manual.
- When selecting a crate or subcrate which doesn't have any tracks, select another crate or subcrate which has tracks, or import tracks into the crate or subcrate.

❖ iTunes tracks aren't displayed in the library.

- Activate **[Show iTunes Library]** in the **[Library + Display]** tab of the **[SETUP]** menu. If **[Show iTunes Library]** is already selected, deactivate it, then activate it again. For details about importing music files, see the Serato DJ Pro software manual.
- When selecting a crate or subcrate which doesn't have any tracks, select another crate or subcrate which has tracks, or import tracks into the crate or subcrate.

❖ **Music files in the library can't be edited.**

- Deactivate **[Protect Library]** in the **[Library + Display]** tab of the **[SETUP]** menu.

❖ **Serato DJ Pro virtual deck isn't displayed. (Off-line player is displayed.)**

- Connect the supplied USB cable correctly. See: Connecting input terminals (page 38).
- Update the Serato DJ Pro to the latest version. See: Installing the software (page 7)

Others

❖ **The Fader Start feature doesn't work.**

- Set a temporary cue.
- Set the **[CROSS FADER ASSIGN]** switch to **[A]** or **[B]** for the channel that you want to start outputting from.

❖ **BPM isn't displayed. / The Sync feature or Auto Loop doesn't work.**

- Activate **[Set Auto BPM]** in the offline player setting, then analyze tracks. For details about analyzing tracks, see the Serato DJ Pro software manual.

❖ **BPM or beatgrid isn't displayed correctly. / The beatgrid isn't correct.**

- Change the BPM analysis range, then analyze tracks again. If the problem persists, set the beatgrid and BPM manually.
- Adjust the beatgrid. For details about adjusting the beatgrid, see the Serato DJ Pro software manual.
- During playback of the track, tap the headphones **[CUE]** button in beat while holding the **[SHIFT]** button (Tap function). The track's BPM and beatgrid can be adjusted.

When you use the Tap function, the deck section's display on the PC/Mac screen switches to the **[Beatgrid Editor]** display. To switch the deck section's display back to how it was before, click **[Edit Grid]** on the PC/Mac screen.

❖ **Playback sound is interrupted when using a DJ software.**

- For Mac, set the appropriate buffer size (latency) value for the DJ software.
- For Windows, set the appropriate buffer size value on the setting utility.

❖ **The BPM is displayed, but the beatgrid isn't. / The Slicer function doesn't work. / Skip mode doesn't work.**

- Activate **[Set Auto BPM]** and **[Set Beatgrid]** in the offline player settings, then analyze tracks. For details about the track analysis, see the Serato DJ Pro software manual.
- Set a beatgrid. For details about beatgrids, see the Serato DJ Pro software manual.

❖ **Jog illumination doesn't rotate during playback, or it rotates but isn't synchronized with the Serato DJ Pro virtual deck. When the deck is switched, the [TEMPO] slider can't be used.**

- Set **[MIDI MODE]** to **[AUTO]** in Utilities mode. (page 96)

❖ **The indicator flashes and operation is strange.**

- If the unit behaves unusually or doesn't turn on, disconnect the AC adapter's power cord from the power outlet, wait a while, then reconnect the AC adapter's power cord to the power outlet.

Liquid crystal display

- Small black or shining points may appear on the liquid crystal display. This is a phenomenon inherent to liquid crystal displays; this isn't a malfunction.
- When the unit is used in cold places, the liquid crystal display may be dark for a while after the unit is turned on. It will reach the normal brightness after a while.
- When the liquid crystal display is exposed to direct sunlight, the light will reflect off of it, making it difficult to see. Block direct sunlight.

Signal flow

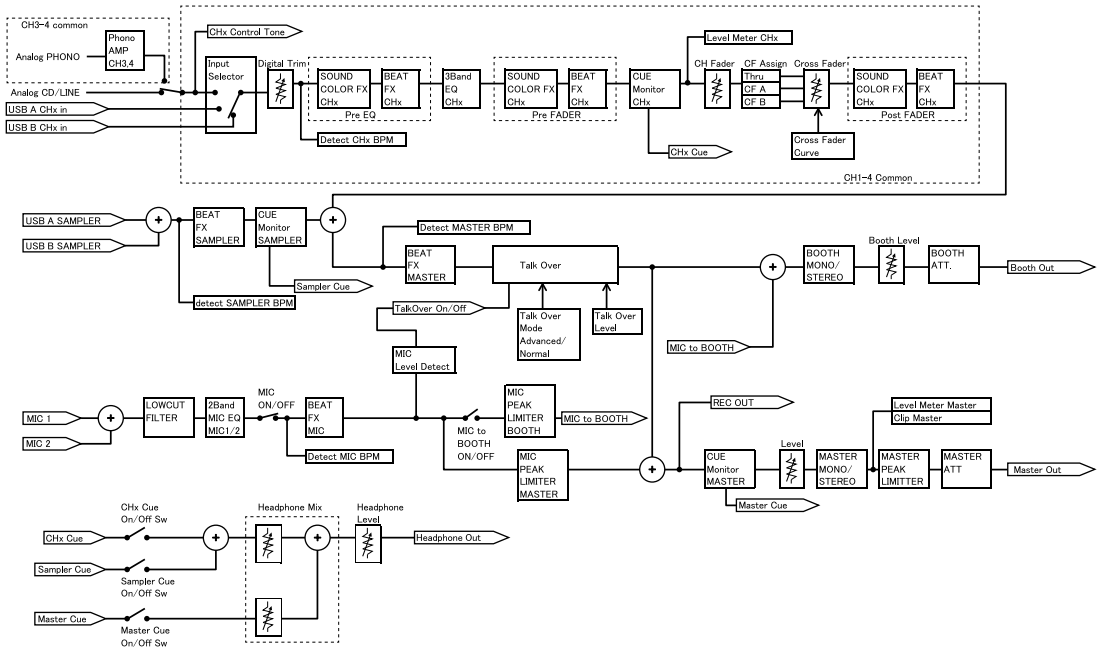

Using the unit as a controller for other DJ applications

The unit also outputs operating data for the buttons and knobs in MIDI format. If you connect a PC/Mac with a built-in MIDI compatible DJ application via the USB cable, you can control the DJ application with the unit. You can also output a music file playing on your PC/Mac from the unit.

To use the unit as a controller for a DJ application other than the Serato DJ Pro, you need to set audio and MIDI details in the DJ application.

- For details, see your DJ application's user guide.

About MIDI messages

For details on this unit's MIDI messages, see: "List of MIDI Messages".

- You can find the List of MIDI Messages from the Pioneer DJ website: pioneerdj.com/

About the driver software

This driver software is an exclusive driver for outputting audio signals from a PC/Mac.

Computer requirements

Supported operating systems

- Mac:
macOS Mojave 10.14 / macOS High Sierra 10.13 / macOS Sierra 10.12 (latest update)
- Windows (32-bit version, 64-bit version):
Windows[®] 10 / Windows[®] 8.1 / Windows[®] 7 (latest service pack)

Checking the latest information on the driver software

For the latest information on the unit's designated driver software, see the Pioneer DJ support page below.

pioneerdj.com/support/

About the installation procedure

- For the operating procedure, see: Installing the software (page 7).

❖ Software end user license agreement

This Software End User License Agreement (“Agreement”) is between you (both the individual installing the Program and any single legal entity for which the individual is acting) (“You” or “Your”) and PIONEER DJ CORPORATION (“Pioneer DJ”).

TAKING ANY STEP TO SET UP OR INSTALL THE PROGRAM MEANS THAT YOU ACCEPT ALL OF THE TERMS OF THIS LICENSE AGREEMENT.

PERMISSION TO DOWNLOAD AND/OR USE THE PROGRAM IS EXPRESSLY CONDITIONED ON YOUR FOLLOWING THESE TERMS.

WRITTEN OR ELECTRONIC APPROVAL IS NOT REQUIRED TO MAKE THIS AGREEMENT VALID AND ENFORCEABLE. IF YOU DO NOT AGREE TO ALL OF THE TERMS OF THIS AGREEMENT, YOU ARE NOT AUTHORIZED TO USE THE PROGRAM AND MUST STOP INSTALLING IT OR UNINSTALL IT, AS APPLICABLE.

1 DEFINITIONS

- 1 “Documentation” means written documentation, specifications and help content made generally available by Pioneer DJ to aid in installing and using the Program.
- 2 “Program” means all or any part of Pioneer DJ’s software licensed to You by Pioneer DJ under this Agreement.

2 PROGRAM LICENSE

- 1 Limited License. Subject to this Agreement's restrictions, Pioneer DJ grants to You a limited, non-exclusive, non-transferable, license (without the right to sublicense):
 - a) To install a single copy of the Program in Your computer or mobile device, to use the Program only for Your personal purpose complying with this Agreement and the Documentation ("Authorized Use");
 - b) To use the Documentation in support of Your Authorized Use;and
 - c) To make one copy of the Program solely for backup purposes, provided that all titles and trademark, copyright and restricted rights notices are reproduced on the copy.
- 2 Restrictions. You won't copy or use the Program or Documentation except as expressly permitted by this Agreement. You won't transfer, sublicense, rent, lease or lend the Program, or use it for third-party training, commercial time-sharing or service bureau use. You won't Yourself or through any third party modify, reverse engineer, disassemble or decompile the Program, except to the extent expressly permitted by applicable law, and then only after You have notified Pioneer DJ in writing of Your intended activities.
- 3 Ownership. Pioneer DJ or its licensor retains all right, title and interest in and to all patent, copyright, trademark, trade secret and other intellectual property rights in the Program and Documentation, and any derivative works thereof. You don't acquire any other rights, express or implied, beyond the limited license set forth in this Agreement.
- 4 No Support. Pioneer DJ has no obligation to provide support, maintenance, upgrades, modifications or new releases for the Program or Documentation under this Agreement.

3 WARRANTY DISCLAIMER

THE PROGRAM AND DOCUMENTATION ARE PROVIDED “AS IS” WITHOUT ANY REPRESENTATIONS OR WARRANTIES, AND YOU AGREE TO USE THEM AT YOUR SOLE RISK. TO THE FULLEST EXTENT PERMISSIBLE BY LAW, PIONEER DJ EXPRESSLY DISCLAIMS ALL WARRANTIES OF ANY KIND WITH RESPECT TO THE PROGRAM AND DOCUMENTATION, WHETHER EXPRESS, IMPLIED, STATUTORY, OR ARISING OUT OF COURSE OF PERFORMANCE, COURSE OF DEALING OR USAGE OF TRADE, INCLUDING ANY WARRANTIES OF MERCHANTABILITY, FITNESS FOR A PARTICULAR PURPOSE, SATISFACTORY QUALITY, ACCURACY, TITLE OR NON-INFRINGEMENT.

4 EXPORT CONTROL AND COMPLIANCE WITH LAWS AND REGULATIONS

You may not use or otherwise export or re-export the Program except as authorized by United States law and the laws of the jurisdiction in which the Program was obtained. In particular, but without limitation, the Program may not be exported or re-exported (a) into any U.S.-embargoed countries or (b) to anyone on the U.S. Treasury Department’s Specially Designated Nationals List or the U.S. Department of Commerce Denied Persons List or Entity List. By using the Program, you represent and warrant that you are not located in any such country or on any such list.

You also agree that you won’t use the Program for any purposes prohibited by United States law, including, without limitation, the development, design, manufacture, or production of nuclear, missile, or chemical or biological weapons.

5 U.S. GOVERNMENT RESTRICTED RIGHTS

The Program and Documentations are “commercial computer software” and “commercial computer software documentation” as those terms are defined in 48 C.F.R. §252.227-7014 (a) (1) (2007) and 252.227-7014 (a) (5) (2007). The U.S. Government’s rights with

respect to the Program and Documentations are limited by this license pursuant to 48 C.F.R. § 12.212 (Computer software) (1995) and 48 C.F.R. §12.211 (Technical data) (1995) and/or 48 C.F.R. §227.7202-3, as applicable. As such, the Program and Documentations are being licensed to the U.S. Government end users:

(a) only as “commercial items” as that term is defined in 48 C.F.R. §2.101 generally and as incorporated in DFAR 212.102; and (b) with only those limited rights as are granted to the public pursuant to this license. Under no circumstance will the U.S. Government or its end users be granted any greater rights than we grant to other users, as provided for in this license. Manufacturer is Pioneer DJ Corporation, 6F, Yokohama i-Mark Place, 4-4-5 Minatomirai, Nishi-ku, Yokohama, Kanagawa 220-0012 Japan

6 DAMAGES AND REMEDIES FOR BREACH

You agree that any breach of this Agreement’s restrictions would cause Pioneer DJ irreparable harm for which money damages alone would be inadequate. In addition to damages and any other remedies to which Pioneer DJ may be entitled, You agree that Pioneer DJ may seek injunctive relief to prevent the actual, threatened or continued breach of this Agreement.

7 TERMINATION

Pioneer DJ may terminate this Agreement at any time upon Your breach of any provision. If this Agreement is terminated, You will stop using the Program, permanently delete it from your computer or mobile device where it resides, and destroy all copies of the Program and Documentation in Your possession, confirming to Pioneer DJ in writing that You have done so. Sections 2.2, 2.3, 2.4, 3, 4, 5, 6, 7 and 8 will continue in effect after this Agreement’s termination.

8 GENERAL TERMS

1 Limitation of Liability. In no event will Pioneer DJ or its subsidiaries be liable in connection with this Agreement or its subject matter,

under any theory of liability, for any indirect, incidental, special, consequential or punitive damages, or damages for lost profits, revenue, business, savings, data, use, or cost of substitute procurement, even if advised of the possibility of such damages or if such damages are foreseeable. In no event will Pioneer DJ's liability for all damages exceed the amounts actually paid by You to Pioneer DJ or its subsidiaries for the Program. The parties acknowledge that the liability limits and risk allocation in this Agreement are reflected in the Program price and are essential elements of the bargain between the parties, without which Pioneer DJ wouldn't have provided the Program or entered into this Agreement.

- 2 The limitations or exclusions of warranties and liability contained in this Agreement don't affect or prejudice Your statutory rights as consumer and shall apply to You only to the extent such limitations or exclusions are permitted under the laws of the jurisdiction where You are located.
- 3 Severability and Waiver. If any provision of this Agreement is held to be illegal, invalid or otherwise unenforceable, that provision will be enforced to the extent possible or, if incapable of enforcement, deemed to be severed and deleted from this Agreement, and the remainder will continue in full force and effect. The waiver by either party of any default or breach of this Agreement won't waive any other or subsequent default or breach.
- 4 No Assignment. You may not assign, sell, transfer, delegate or otherwise dispose of this Agreement or any rights or obligations under it, whether voluntarily or involuntarily, by operation of law or otherwise, without Pioneer DJ's prior written consent. Any purported assignment, transfer or delegation by You will be null and void. Subject to the foregoing, this Agreement will be binding upon and will inure to the benefit of the parties and their respective successors and assigns.

Additional information

- 5 Entire Agreement. This Agreement constitutes the entire agreement between the parties and supersedes all prior or contemporaneous agreements or representations, whether written or oral, concerning its subject matter. This Agreement may not be modified or amended without Pioneer DJ's prior and express written consent, and no other act, document, usage or custom will be deemed to amend or modify this Agreement.
- 6 You agree that this Agreement shall be governed and construed by and under the laws of Japan.

About trademarks and registered trademarks

- Pioneer DJ is a trademark of PIONEER CORPORATION and is used under license.
 - Mac, macOS, OS X and Finder are trademarks of Apple Inc., registered in the U.S. and other countries.
 - Windows is a registered trademark of Microsoft Corporation in the United States and other countries.
 - Intel and Intel Core are trademarks of Intel Corporation in the U.S. and other countries.
 - Serato DJ Pro is a registered trademark of Serato Limited.
 - ASIO is a trademark of Steinberg Media Technologies GmbH.
- The names of companies and products mentioned herein are trademarks or registered trademarks of their respective owners.

Cautions on copyrights

Recordings you have made are for your personal enjoyment and according to copyright laws may not be used without the consent of the copyright holder.

- Music recorded from CDs, etc. is protected by the copyright laws of individual countries and by international treaties. It is the full responsibility of the person who has recorded the music to ensure that it is used legally.
- When handling music downloaded from the Internet, etc., it is the full responsibility of the person who has downloaded the music to ensure that it is used in accordance with the contract concluded with the download site.

The specifications and design of this product are subject to change without notice.

© 2019 Pioneer DJ Corporation.
All rights reserved.
<DRI1615-B>