

# Instruction Manual

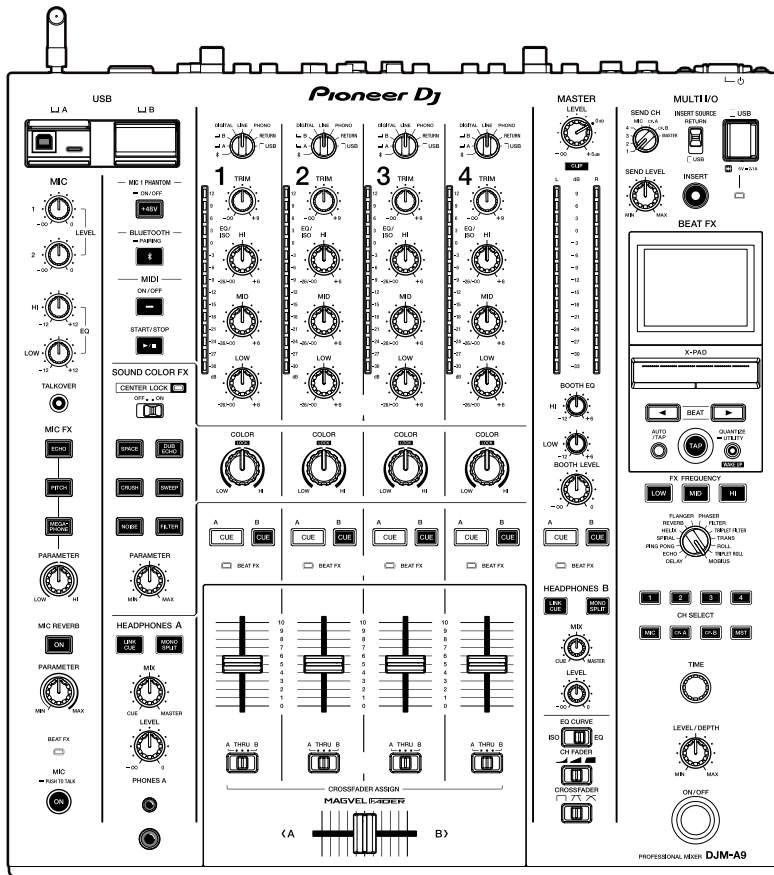

DJ Mixer

# DJM-A9

[pioneerdj.com/support/](http://pioneerdj.com/support/)

[rekordbox.com](http://rekordbox.com)

For FAQs and other support information for this product, visit the websites above.

---

---

# Contents

<b>Before you start</b> .....	<b>5</b>
How to read this manual .....	5
What's in the box.....	5
User guides .....	6
<b>PRO DJ LINK</b> .....	<b>7</b>
<b>Part names</b> .....	<b>9</b>
Top panel .....	9
Front panel.....	10
Rear panel.....	10
<b>PC/Mac setup</b> .....	<b>13</b>
Installation .....	13
Setting Utility .....	15
<b>Connections (basic styles)</b> .....	<b>20</b>
Connecting to the input terminals.....	20
Connecting to the output terminals .....	21
Connecting to the terminals on the top and front panels.....	22
Connecting external effects units .....	23
<b>Audio output</b> .....	<b>24</b>
Channel section/master section/fader curve section.....	24
Outputting sound.....	27
Adjusting the sound.....	28
Setting the fader curve .....	28
Adjusting the left/right sound balance .....	29
<b>Monitoring sound</b> .....	<b>31</b>
Headphones (A/B) section .....	31
Monitoring with headphones .....	32

Booth section .....	33
Using a booth monitor .....	33
<b>Microphone .....</b>	<b>34</b>
MIC section .....	34
Using a microphone .....	36
<b>Sound Color FX.....</b>	<b>38</b>
Sound Color FX section .....	38
Using Sound Color FX .....	39
Sound Color FX types and settings.....	40
<b>Multi I/O.....</b>	<b>42</b>
MULTI I/O section .....	44
Using Multi I/O.....	45
<b>Beat FX .....</b>	<b>46</b>
Beat FX section.....	47
Screen display.....	49
Using Beat FX.....	50
Setting the BPM manually.....	51
Beat FX types and settings .....	52
<b>USB/MIDI.....</b>	<b>57</b>
USB/MIDI section.....	57
Controlling MIDI software .....	58
<b>Bluetooth .....</b>	<b>59</b>
Bluetooth section.....	59
Pairing with a Bluetooth device .....	60
Using a Bluetooth device .....	61
<b>Wireless LAN (Wi-Fi) .....</b>	<b>62</b>
Connecting and disconnecting the wireless antenna .....	62
Setting wireless LAN (Wi-Fi) .....	64
Connecting the unit to a wireless network.....	65

Viewing the Wireless LAN (Wi-Fi) information .....	72
Viewing the LAN information .....	73
<b>Settings.....</b>	<b>74</b>
UTILITY screen .....	74
Changing the settings .....	75
Utility settings .....	76
Saving MY SETTINGS to a storage device .....	85
Calling up MY SETTINGS saved on a storage device .....	86
Sound check .....	87
Restoring the factory settings.....	88
<b>Specifications .....</b>	<b>89</b>
Block diagram .....	92
<b>Additional information .....</b>	<b>94</b>
Troubleshooting .....	94
LCD display .....	98
Trademarks and registered trademarks .....	99
Software license notice .....	100
Cautions on copyrights.....	108

---

---

# Before you start

---

---

## How to read this manual

- Thank you for choosing this Pioneer DJ product.  
Be sure to read this manual, the “Quick Start Guide” and the “Precautions for Use” which are also included with this product. These documents include important information that you should understand before using the unit.
- In this manual the names of buttons, knobs and terminals that appear on the product, and the names of buttons, menus etc. in the software on your PC/Mac or mobile device, are indicated within square brackets ([ ]). (e.g. **[File]**, **[CUE]** button)
- Please note that the software screens and their specifications, as well as the external appearance and specifications of the hardware, are subject to change without notice.
- Please note that depending on the operating system version, web browser settings, etc. operation may differ from the ways described in this manual.
- Please note that the language on the screens of the software described in this manual may differ from the language on your screen.

---

---

## What's in the box

- Power cord
- Warranty (for some regions)<sup>\*1</sup>
- Quick Start Guide
- Precautions for Use

\*1 Only products in Europe.

Products in North America and Japan include warranty information in the “Precautions for Use”.

---

## User guides

### ❖ rekordbox Introduction, Instruction Manual

Refer to the “rekordbox Introduction” to find out how to set up rekordbox, and see the “Instruction Manual” to find out how to use rekordbox.

Visit the URL below to find these user guides.

[rekordbox.com/manual](https://rekordbox.com/manual)

---

---

# PRO DJ LINK

You can use PRO DJ LINK functions by connecting the unit via a LAN cable to a PRO DJ LINK compatible multi player and a PC/Mac running rekordbox.

- You can connect up to 4 multi players and up to 2 computers (PC/Mac) to the unit via a switching hub.
- Use a 100BASE-TX compatible switching hub that is supported by multi players. Some switching hubs may not work properly with selected devices.
- Set the multi player number to the channel number which the audio cable is connected to.

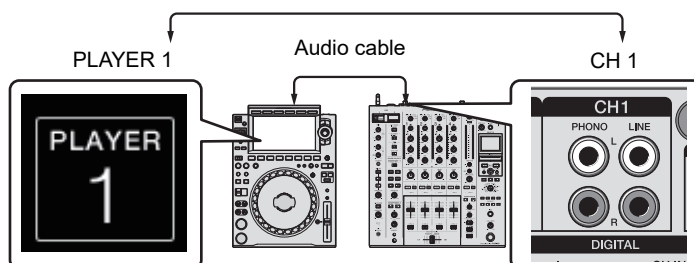

- For details on PRO DJ LINK, see the instruction manuals for the relevant multi players and rekordbox.

[pioneerdj.com/support/](http://pioneerdj.com/support/)

## ❖ Quantize

When you are playing a track analyzed by rekordbox, the unit applies BEAT FX by automatically synchronizing it with the beat according to the track's GRID information. This happens even if you operate the **[ON/OFF]** button in the Beat FX section and X-PAD roughly.

## ❖ Link Monitor

You can browse and monitor via headphones the sound of tracks in rekordbox on a PC/Mac, or on a multi player, while playing a different track (page 31).

- To monitor the sound of rekordbox, click **[File] > [Preferences] > [Audio]** and mark the **[Use "LINK MONITOR" of PIONEER DJ Mixers]** check box in rekordbox.
- You can't monitor the sound of a track from a multi player if the player doesn't support the LINK MONITOR function.

## ❖ Status Information

You can check on-air information with multi players.

## ❖ Stagehand

You can use the Stagehand app on a tablet to check the status of Pioneer DJ multi players or mixers and remote-control them.

- You can use the Stagehand app while using PRO DJ LINK.
- For details, refer to the instruction manuals for the Stagehand app and rekordbox.

[pioneerdj.com/en/product/software/](http://pioneerdj.com/en/product/software/)

[rekordbox.com/manual](http://rekordbox.com/manual)



# Part names

## Top panel

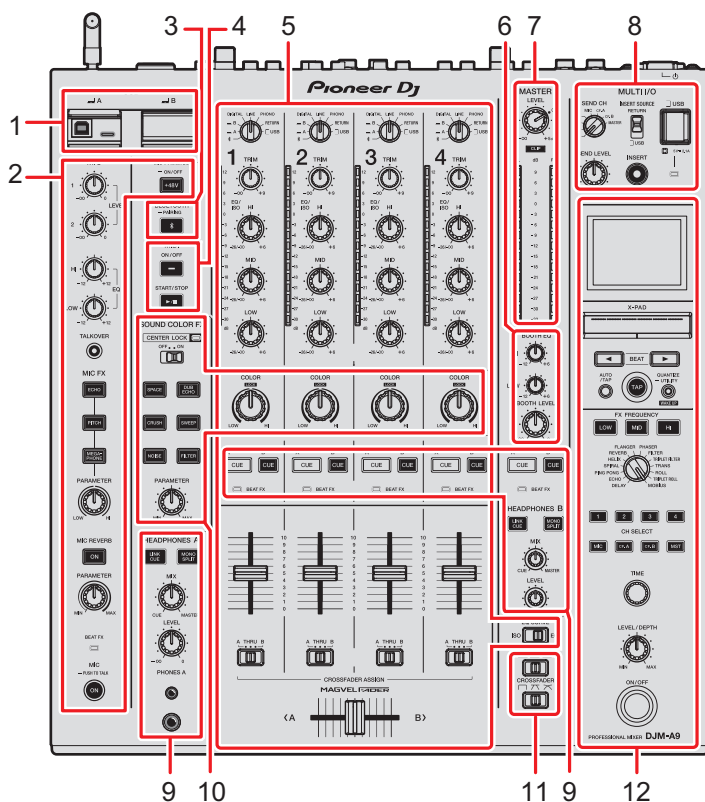

1. **USB section** (page 57)
2. **MIC section** (page 34)
3. **Bluetooth section** (page 59)
4. **MIDI section** (page 57)
5. **Channel section** (page 24)
6. **Booth section** (page 33)
7. **Master section** (page 24)
8. **MULTI I/O section** (page 44)
9. **Headphones (A/B) section** (page 31)
10. **Sound Color FX section** (page 38)
11. **Fader curve section** (page 24)
12. **Beat FX section** (page 47)

## Front panel

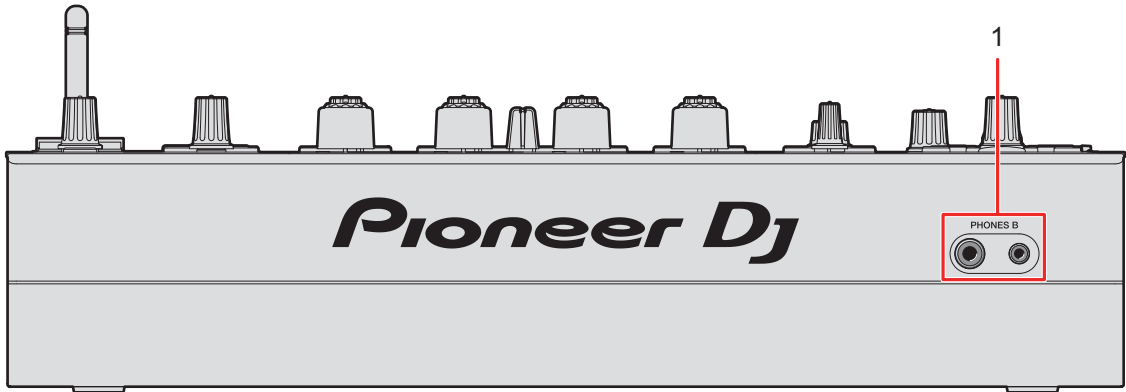

1. **PHONES B terminals** (pages 22, 32)

## Rear panel

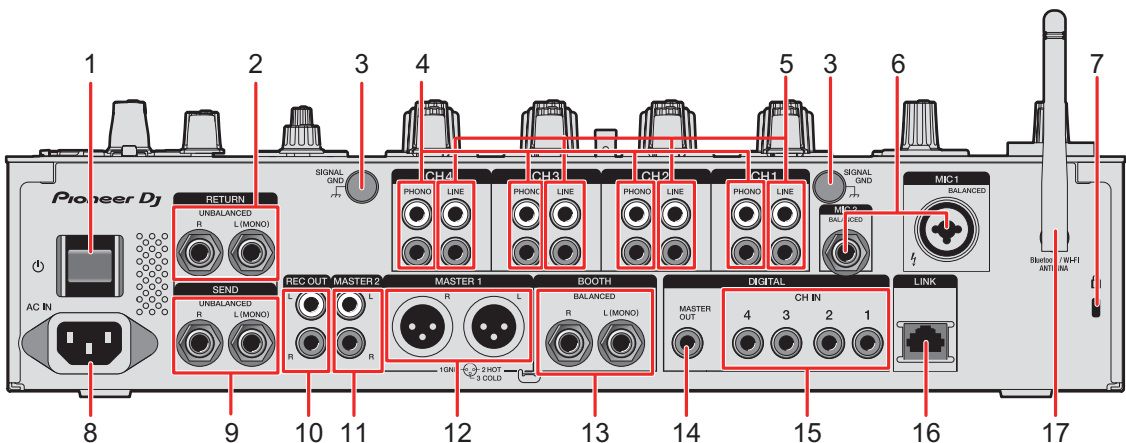

1. **⏻ button**  
Turns the unit on and off.
2. **RETURN terminals (1/4"/6.35 mm, TS)** (page 23)  
Connect to output terminals on external effects units.
  - If you connect a device to the [L (MONO)] terminal only, the sound input to the [L (MONO)] terminal is also input to the [R] channel.
3. **SIGNAL GND terminal** (page 20)  
Connect a turntable's ground wire.  
Reduces noises that occur when a turntable is connected to the unit.

## 4. **PHONO terminals (RCA)** (page 20)

Connect phono-level (MM cartridge) output devices.

- Do not input line-level signals to the terminals.
- Remove the short-circuit pin plugs from the terminals when connecting devices. When you aren't using the terminals, attach the short-circuit pin plugs to cut out external noises.

### **WARNING**

Keep the short-circuit pin plugs out of the reach of children and infants. If accidentally swallowed, contact a doctor immediately.

## 5. **LINE terminals (RCA)** (page 20)

Connect multi players or line-level output devices.

## 6. **MIC 1 terminal (XLR or 1/4"/6.35 mm, TRS), MIC 2 terminal (1/4"/6.35 mm, TRS)** (page 20)

## 7. **Kensington security slot**

Connect a cable lock.

## 8. **AC IN** (page 20)

Connect to a power outlet with the supplied power cord.

## 9. **SEND terminals (1/4"/6.35 mm, TS)** (page 23)

Connect to input terminals on external effects units.

- If you connect equipment to the [**L (MONO)**] terminal only, mono sound is output.

## 10. **REC OUT terminals (RCA)** (page 21)

Connect a device for recording.

## 11. **MASTER 2 terminals (RCA)** (page 21)

Connect to analog input terminals on a power amplifier, etc.

## 12. **MASTER 1 terminals (balanced XLR)** (page 21)

Connect to analog input terminals on a power amplifier, etc.

- Use the terminals for balanced output only.
- Do not connect a power cord from another product to the terminals.

## 13. **BOOTH terminals (1/4"/6.35 mm, TRS)** (page 21)

Connect a booth monitor.

- Use the terminals for balanced output only.
- If you connect equipment to the [**L (MONO)**] terminal only, mono sound is output.

14. **DIGITAL MASTER OUT terminal (RCA)** (page 21)

Connect to a digital terminal on a preamplifier, etc.

Outputs the master sound in SPDIF format.

- Do not connect to an analog input terminal.

15. **DIGITAL CH IN terminals (RCA)** (page 20)

Connect to a digital coaxial output terminal on a multi player, etc.

- Sound may break when the output signal's sampling frequency changes.

16. **LINK terminal** (page 20)

Connect to a LINK terminal on a PC/Mac running rekordbox or a PRO DJ LINK compatible multi player.

- Use a switching hub (100BASE-TX compatible type) to connect multiple devices.

17. **Wireless antenna** (page 62)

Connect and raise the antenna when you connect via Wi-Fi or Bluetooth.

---

---

# PC/Mac setup

To input or output your PC/Mac's audio to/from the unit, install the dedicated audio driver software and/or Setting Utility on your computer.

If you install the dedicated software to your PC (Windows), the Setting Utility and audio driver software will be installed.

If you use a Mac, only the Setting Utility will be installed.

- For information on the latest system requirements, compatibility, and supported operating systems, visit the URL below.

[pioneerdj.com/support/](http://pioneerdj.com/support/)

- Operation isn't guaranteed on all PC/Mac models, even if the system requirements are met.
- Operation isn't guaranteed when multiple units are connected to a PC/Mac.
- If a PC (Windows) without the dedicated audio driver software installed is connected to the unit, errors may occur on the PC.
- Malfunctions may occur due to incompatibility with other software installed on a PC/Mac.

---

---

## Installation

### ❖ Notes on installation

- Turn the unit off and disconnect the USB cable connected to the unit and the PC/Mac before installation.
- Close all applications running on the PC/Mac before installation.
- You'll need admin rights to install the dedicated software to your PC/Mac.
- Read the Software License Agreement terms carefully before installation.
- If you quit the installation halfway through, perform the installation procedure from the beginning again.
- After the installation is complete, connect the PC/Mac to the unit.
- Operation isn't guaranteed on all PC/Mac models.

---

## Downloading the dedicated software

**1 Visit the URL below.**

[pioneerdj.com/support/](http://pioneerdj.com/support/)

**2 Click [Software & firmware updates].**

**3 Click [DJM-A9] under [DJ MIXER].**

**4 Click [Drivers].**

**5 Click [Download link] and save the file.**

- Download the software dedicated to your PC/Mac.

---

## Installing the dedicated software

**1 Unzip the downloaded dedicated software.**

**2 Double-click the installation file.**

- Double-click “DJM-A9\_#.###.exe” if you’re using a PC (Windows), or “DJM-A9\_M\_#.###.dmg” → “DJM-A9SettingUtility.pkg” if you’re using a Mac (# indicates the version number of the software).

**3 Read the Software License Agreement terms carefully.**

**If you agree to the terms, mark the [Agree] check box and click [OK].**

- If you don’t agree to the Software License Agreement terms, click [**Disagree**] (for Mac)/[**Cancel**] (for Windows) to cancel the installation.

**4 Follow the on-screen instructions to complete the installation.**

---

## Setting Utility

Once you've installed the dedicated software on your PC/Mac, you can use the Setting Utility to check and set connections between the unit and a PC/Mac.

---

### Launching Setting Utility

#### ❖ For Mac

- 1 Open the [Applications] folder in Finder.
- 2 Click [Pioneer] → [DJM-A9] → [DJM-A9 Setting Utility].

#### ❖ For PC (Windows)

- 1 Open the Start menu and click [Pioneer] → [DJM-A9 Setting Utility].

---

### Checking the status of the input selector switches on the unit

- 1 Click the [MIXER INPUT] tab.

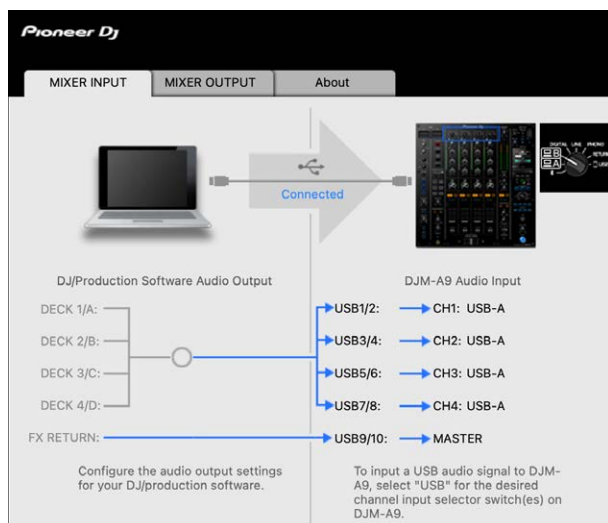

## Setting the audio data output from the unit to a PC/Mac

- 1 Click the [MIXER OUTPUT] tab.
- 2 Click the pull-down list under [DJM-A9 Audio Output] and select the audio data output from the unit to the PC/Mac.

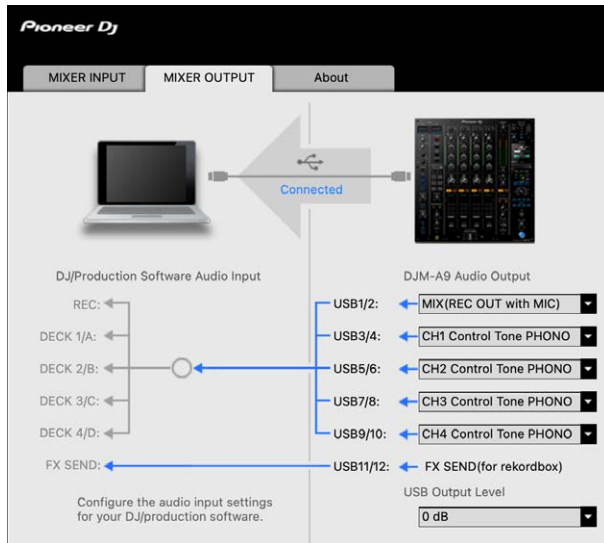

➤ Read more: DJM-A9 Audio Output pull-down list (page 19)

- 3 Click the pull-down list under [USB Output Level] and select a level of volume to output from the unit.

- Set the volume in [USB Output Level] when you can't produce as much volume as you expect using the volume adjustment in your DJ application. Note that the sound may be distorted if you set the volume too high.



---

## Adjusting the buffer size (for Windows ASIO)

- Close any running applications (DJ applications, etc.) which use the unit as the default audio device before adjusting the buffer size.

**1 Click the [ASIO] tab.**

**2 Adjust the buffer size with the slider.**

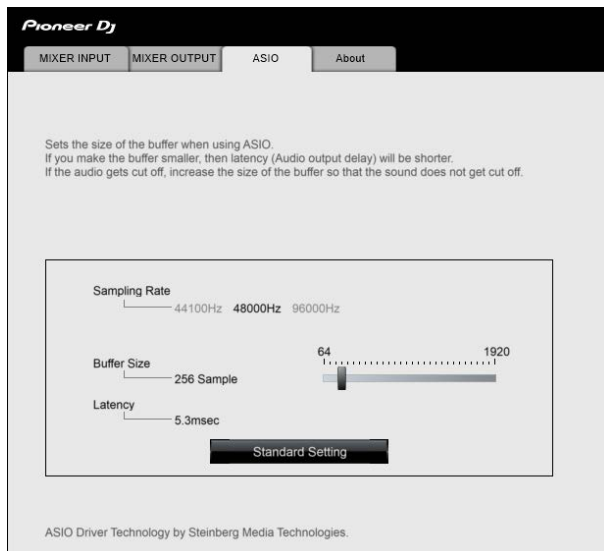

- Breaks in sound are less likely to occur if you set a large buffer size, but this increases lag time due to the latency of audio data transmission.

## Checking the firmware and dedicated software versions

### 1 Click the [About] tab.

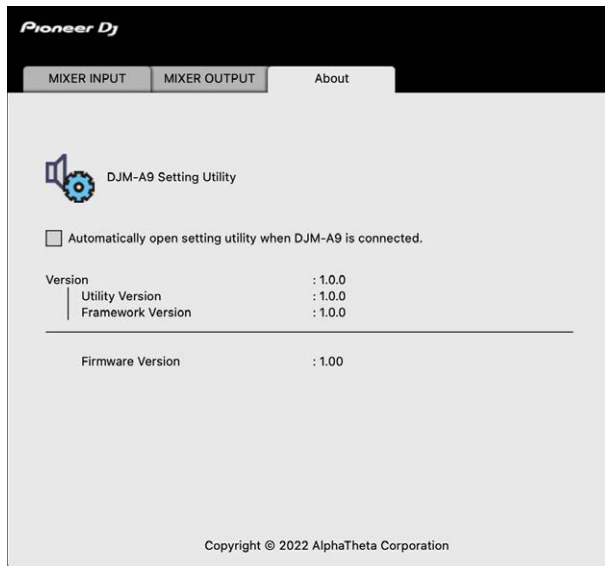

## DJM-A9 Audio Output pull-down list

- USB 11/12 is fixed to [FX SEND(for rekordbox)] (available for software applications that support the function).

#: indicates channel number

USB 1/2	USB 3/4, USB 5/6, USB 7/8, USB 9/10
MIX(REC OUT with MIC) <sup>[1]</sup>	CH# Control Tone PHONO <sup>[2]</sup>
Pre CH1 Fader	CH# Control Tone LINE <sup>[2]</sup>
Pre CH2 Fader	CH# Control Tone DIGITAL <sup>[2]</sup>
Pre CH3 Fader	Pre CH# Fader
Pre CH4 Fader	Post CH# Fader
Post CH1 Fader	CROSSFADER A
Post CH2 Fader	CROSSFADER B
Post CH3 Fader	MIC
Post CH4 Fader	MIX(REC OUT with MIC) <sup>[1]</sup>
CROSSFADER A	MIX(REC OUT without MIC) <sup>[1]</sup>
CROSSFADER B	-
MIC	-
MIX(REC OUT without MIC) <sup>[1]</sup>	-

<sup>[1]</sup> For uses other than recording, be sure to set the DJ application so that no sound loop occurs. Sound may be input or output at an unintended volume level when a sound loop occurs.

<sup>[2]</sup> Available for software applications that support the function. Outputs sound at the volume input to the unit regardless of the [USB Output Level] setting.

---

---

# Connections (basic styles)

Turn the unit off and disconnect the power cord before connecting other units.

Connect the power cord after all the connections are complete.

- Use the supplied power cord.
- Read the instruction manuals for the devices you are going to connect with the unit.
- For wired LAN connections, use a Cat5e (or higher) STP cable.
- Do not disconnect a LAN cable when using PRO DJ LINK.

---

---

## Connecting to the input terminals

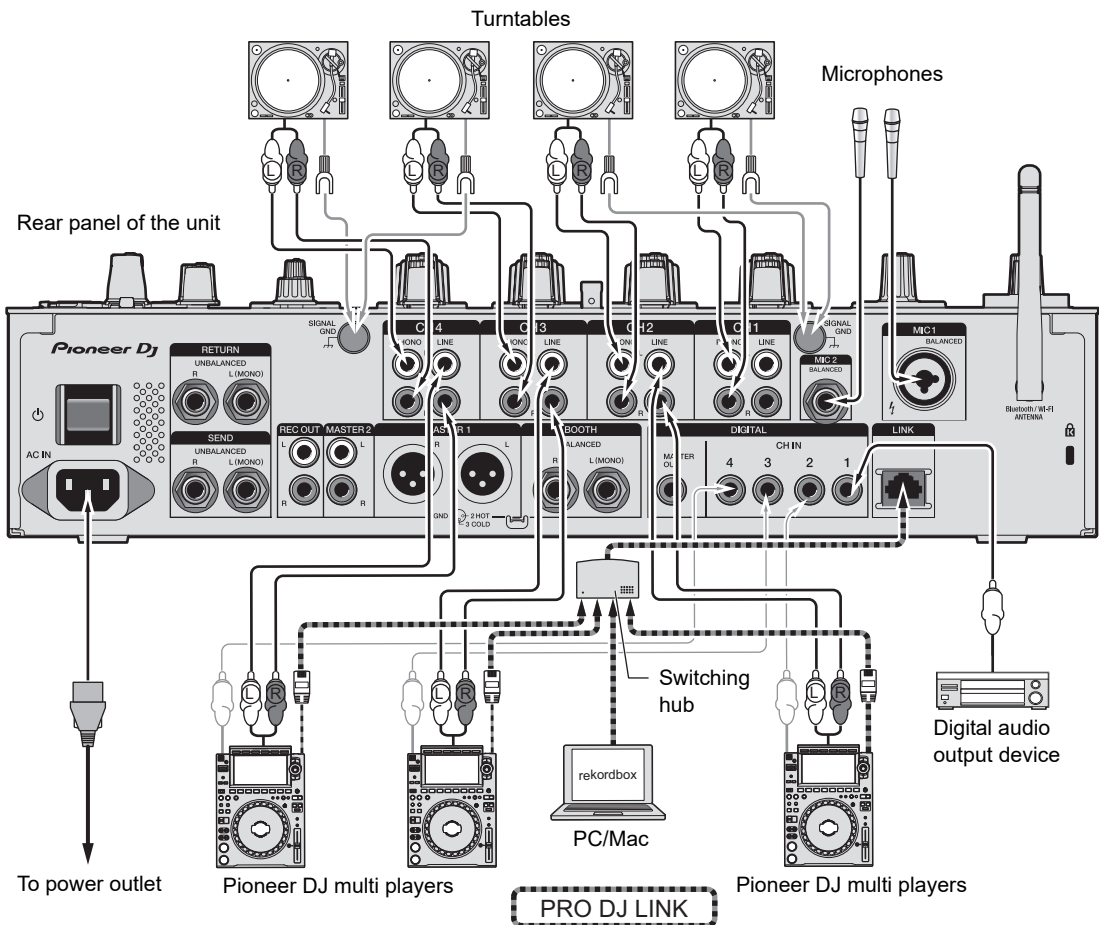

➡ Read more: PRO DJ LINK (page 7)

## Connecting to the output terminals

Rear panel of the unit

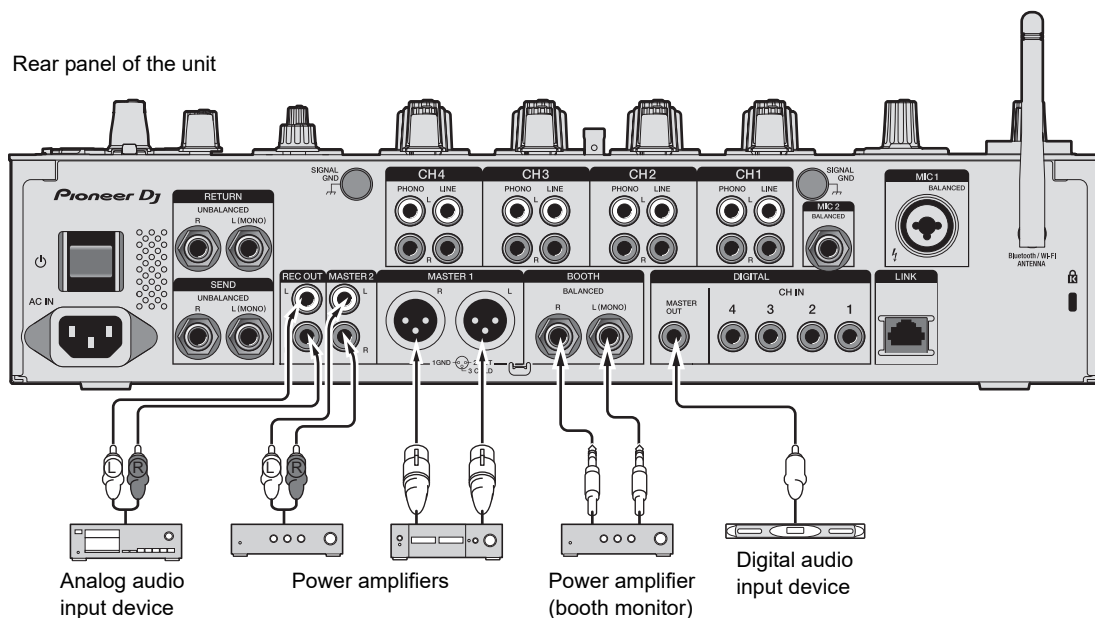

- Use the [**MASTER 1**] terminals for balanced output only. Connecting the terminals to unbalanced inputs (RCA, etc.) with an XLR-RCA conversion cable (conversion adapter), etc. results in unwanted noises and/or poor sound quality.
- Use the [**MASTER 2**] terminals for unbalanced input (RCA, etc.).
- Use the [**BOOTH**] terminals for balanced output only. Connecting the terminals to unbalanced inputs results in unwanted noises and/or poor sound quality.
- Do not connect a power cord from another product to the [**MASTER 1**] terminals.

## Connecting to the terminals on the top and front panels

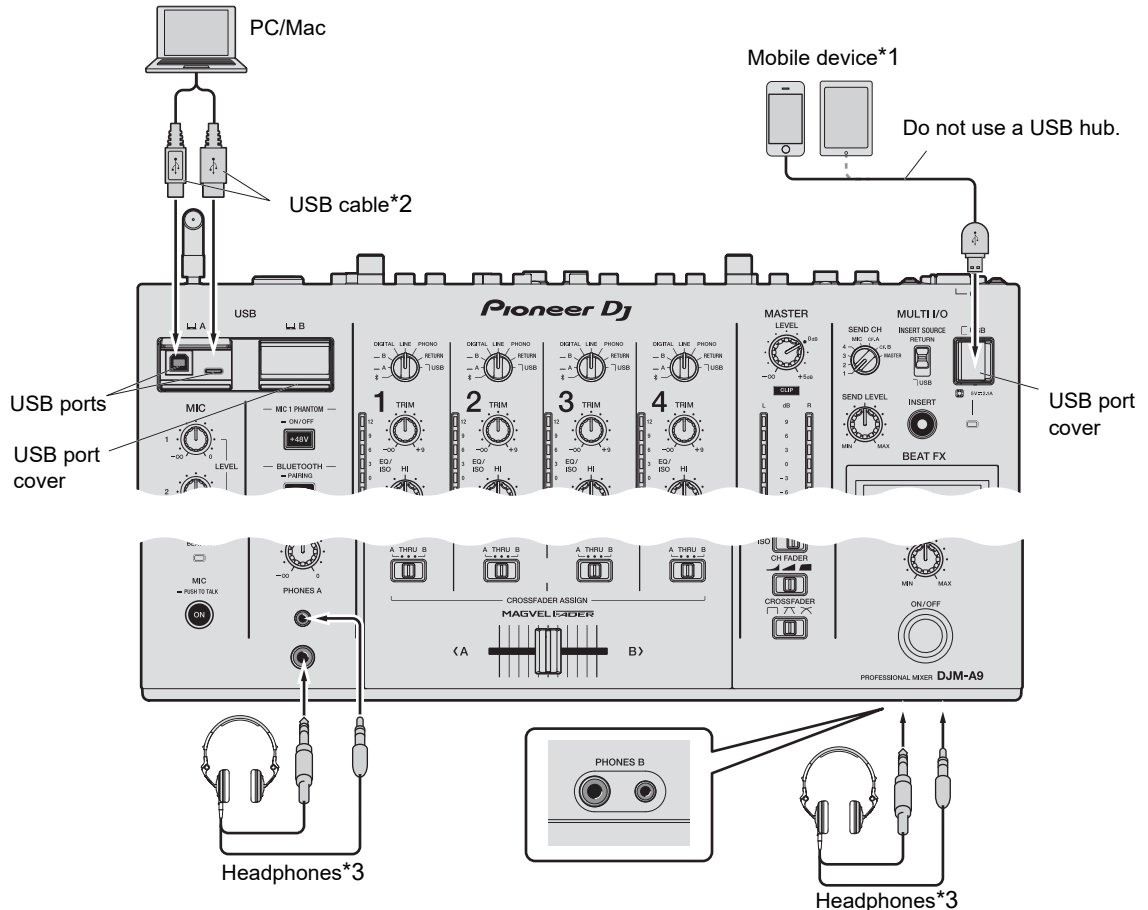

\*1 Use a cable supplied with the mobile device to connect it to the unit.  
For a list of the mobile devices supported by the unit, visit the URL below.

[pioneerdj.com/support/](http://pioneerdj.com/support/)

\*2 We recommend using a USB cable to connect this unit directly with a PC/Mac.  
If you want to use a USB hub, use a product recommended by the manufacturer of your PC/Mac.  
We don't guarantee compatibility of all USB hubs.

\*3 Connect headphones to one of the terminals (jack or mini-jack). If you use both terminals at the same time, the volume for headphones may decrease and/or the sound quality may deteriorate.

- Do not connect mobile devices to the USB Type-B or Type-C ports.
- To input or output your PC/Mac's audio to/from the unit, install the dedicated software on your computer (page 13).
- Do not press or pull the USB port covers with excessive force, or they may be damaged.

## Connecting external effects units

### Connecting to the MULTI I/O terminals

You can use external effects units or mobile devices by connecting them to the MULTI I/O terminals as follows.

- [SEND] terminals (output) → effects unit → [RETURN] terminals (input)
- Mobile device connection terminal (USB port) (input/output port) → mobile device
- Be sure to connect external effects units to the [RETURN] terminals (input) as well.

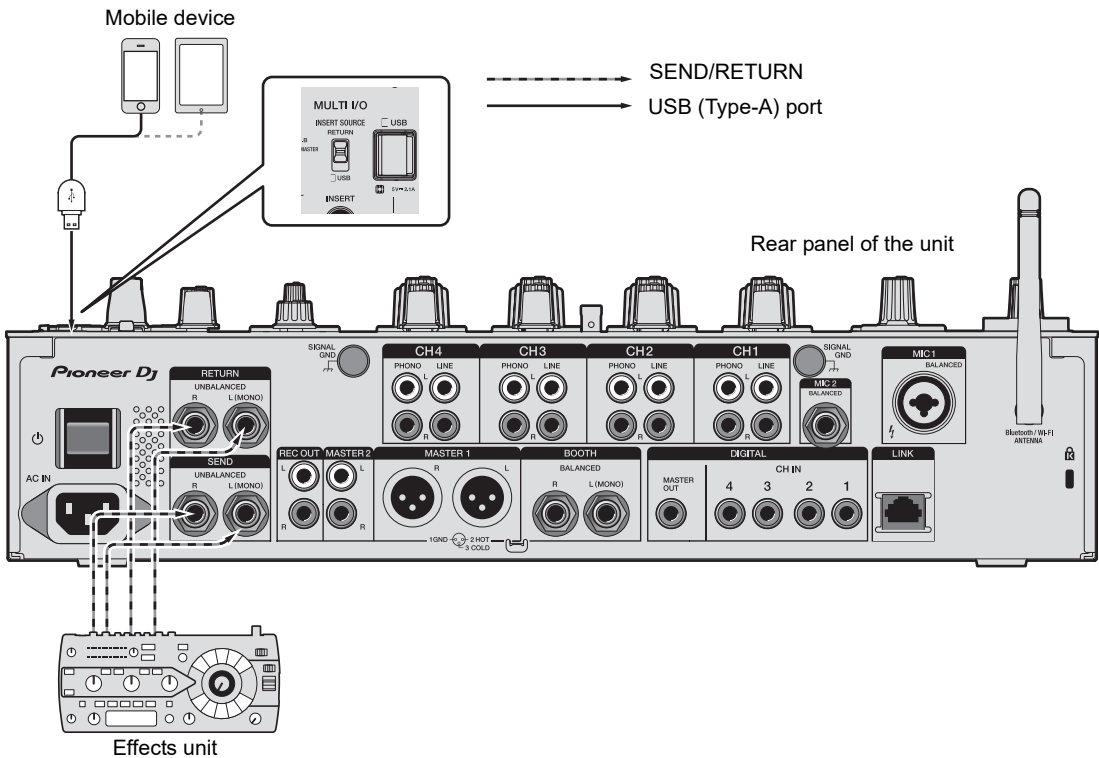

➡ Read more: Multi I/O (page 42)

# Audio output

Follow the procedures below to output and adjust sound.

- Outputting sound (page 27)
- Adjusting the sound (page 28)
- Setting the fader curve (page 28)
- Adjusting the left/right sound balance (page 29)

🔊 To output sound to the [BOOTH] terminals, see Using a booth monitor (page 33).

## Channel section/master section/fader curve section

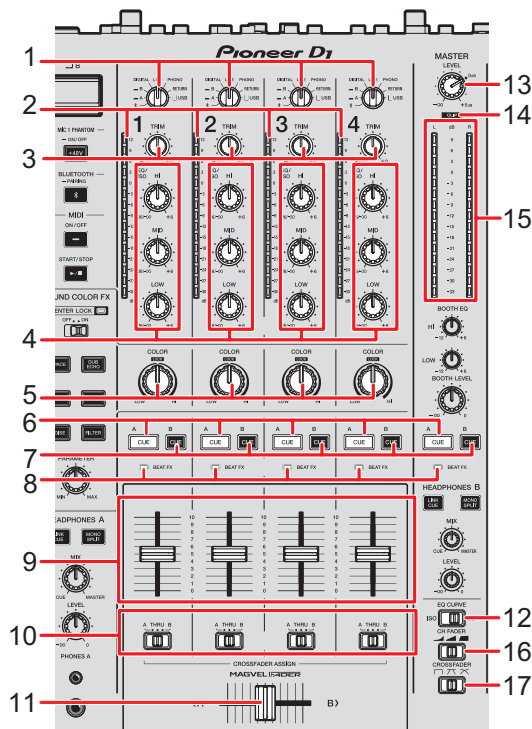



### ❖ Channel section

#### 1. Input selector switch

Selects an input sound source.



- [  ]: Selects a PC/Mac or mobile devices connected via Bluetooth.
- [  **A, B** ]: Selects a PC/Mac connected to the [ **USB** ] port.
- [ **DIGITAL** ]: Selects a multi player connected to the [ **DIGITAL CH IN** ] terminals.
- [ **LINE** ]: Selects a multi player, etc. connected to the [ **LINE** ] terminals.
- [ **PHONO** ]: Selects a turntable connected to the [ **PHONO** ] terminals.
- [ **RETURN** ]: Selects the effect sound of a device connected to the [ **RETURN** ] terminals.
- [  **USB** ]: Selects the effect sound of a device connected to the mobile device connection terminals.

## 2. **Channel level indicator**

Displays the volume level before the sound passes through the channel fader.

## 3. **TRIM knob**

Adjusts the volume for the channel input sound.

## 4. **EQ/ISO (HI, MID, LOW) knobs**

Adjusts the volume of each frequency band.

Each knob adjusts in the following range.

- [ **HI** ]: -26 dB to +6 dB
- [ **MID** ]: -26 dB to +6 dB
- [ **LOW** ]: -26 dB to +6 dB

## 5. **COLOR knob** (page 38)

## 6. **CUE A button** (page 32)

## 7. **CUE B button** (page 32)

## 8. **Beat FX indicator**

Lights up on the channel selected with the [ **CH SELECT** ] button.

## 9. **Channel fader**

Adjusts the volume for the channel output sound according to the channel fader curve set with the [ **CH FADER** ] switch. Moving it up increases the volume, and down decreases the volume.

## 10. **CROSSFADER ASSIGN (A, THRU, B) selector switch**

Assigns the channel output sound to the crossfader.

- [ **A** ]: Assigns to the [ **A** ] (left) side.

- **[THRU]**: Bypasses the crossfader.
- **[B]**: Assigns to the **[B]** (right) side.

## 11. Crossfader

Adjusts the volume balance between the channel output sounds according to the crossfader curve specified with the **[CROSSFADER]** switch. Moving it to the **[A]** side outputs the sound assigned to **[A]**, and to the **[B]** side outputs the sound assigned to **[B]**.

## 12. EQ CURVE switch

Selects the function (isolator or equalizer) to adjust with the **[EQ/ISO (HI, MID, LOW)]** knobs.

## ❖ Master section

### 13. LEVEL knob

Adjusts the volume for the master sound.

### 14. CLIP indicator

Lights up when excessive volume is output from the **[MASTER 1]** or **[MASTER 2]** terminals.



### 15. Master level indicator

Displays the volume level of the master sound output to the **[MASTER 1]**, **[MASTER 2]** or **[DIGITAL MASTER OUT]** terminals.

## ❖ Fader curve section

### 16. CH FADER switch





Sets the channel fader curve.

- : Steeply raises the volume when the channel fader is moved close to the top position.
- : Gradually raises the volume as the channel fader is moved up.
- : Steeply raises the volume as the channel fader is moved from the bottom position.

### 17. CROSSFADER switch

Sets the crossfader curve.

- : Steeply raises the volume of the sound assigned to the other side as the crossfader is moved from one side (**[A]** or **[B]**) to the other (e.g. moving the crossfader away from the **[A]** side steeply increases the volume of the **[B]** side).

- : Applies the intermediate setting between  and .
- : Gradually raises the volume of the sound assigned to the other side as the crossfader is moved from one side ([A] or [B]) to the other, and decreases the volume of the sound on the side it's moving away from (e.g. moving the crossfader away from the [A] side gradually increases the volume of the [B] side while gradually decreasing the volume of the [A] side).

---

---

## Outputting sound

---

### Adjusting the channel input volume

- 1 Turn the input selector switch to select an input sound source.**
- 2 Turn the [TRIM] knob to adjust the volume for the input sound.**

The channel level indicator lights up when sound is input to the channel.

---

### Adjusting the channel output volume

- 1 Move the channel fader to adjust the volume for the output sound.**
- 2 Set the [CROSSFADER ASSIGN (A, THRU, B)] selector switch to assign the output sound to the crossfader.**
  - If selecting [THRU], this completes the volume adjustment for the channel output sound.
- 3 Move the crossfader to adjust the volume balance of the two channels.**

---

## Adjusting the master sound volume

- 1 Turn the [LEVEL] knob to adjust the volume for the master sound.

The master level indicator lights up when the master sound is output.

---

---

## Adjusting the sound

- 1 Sets the [EQ CURVE] switch to the function to be adjusted.
- 2 Turn the [EQ/ISO (HI, MID, LOW)] knobs to adjust the volume of each band.

---

---

## Setting the fader curve

Set the channel fader curve and crossfader curve.

- 1 Sets the [CH FADER] switch to a channel fader curve.
- 2 Sets the [CROSSFADER] switch to a crossfader curve.

---

## Adjusting the left/right sound balance

You can adjust the left/right balance for sounds output from the following terminals.

- [MASTER 1]
- [MASTER 2]
- [BOOTH]
- [REC OUT]
- [DIGITAL MASTER OUT]
- [USB]
- [PHONES A]
- [PHONES B]

- You can adjust the left/right balance for sound output from the USB port only when [MIX(REC OUT with MIC)] or [MIX(REC OUT without MIC)] is selected for [Mixer Audio Output] in Settings Utility (page 16).

### 1 Press and hold the [QUANTIZE/UTILITY (WAKE UP)] button.

The Utility menu appears.

➡ Read more: Settings (page 74).

### 2 Turn the [TIME] knob in the Beat FX section or press the [BEAT ◀] or [BEAT ▶] button to select [MIXER SETTINGS], and press the [TAP] button.

The setting items under [MIXER SETTINGS] appear.

### 3 Turn the [TIME] knob or press the [BEAT ◀] or [BEAT ▶] button to select [BALANCE], and press the [TAP] button.

The [BALANCE] screen appears.

### 4 Turn the [TIME] knob or press the [BEAT ◀] or [BEAT ▶] button to adjust the left/right balance.

- Only the left channel sound of stereo audio is output when set to the [L] (leftmost) position, and only the right channel sound is output when set to the [R] (rightmost) position.

## **5 Press the [TAP] button.**

- To cancel the setting, press the [AUTO/TAP] button.

## **6 Press the [QUANTIZE/UTILITY (WAKE UP)] button.**

The [UTILITY] screen closes.

---

---

# Monitoring sound

---

---

## Headphones (A/B) section

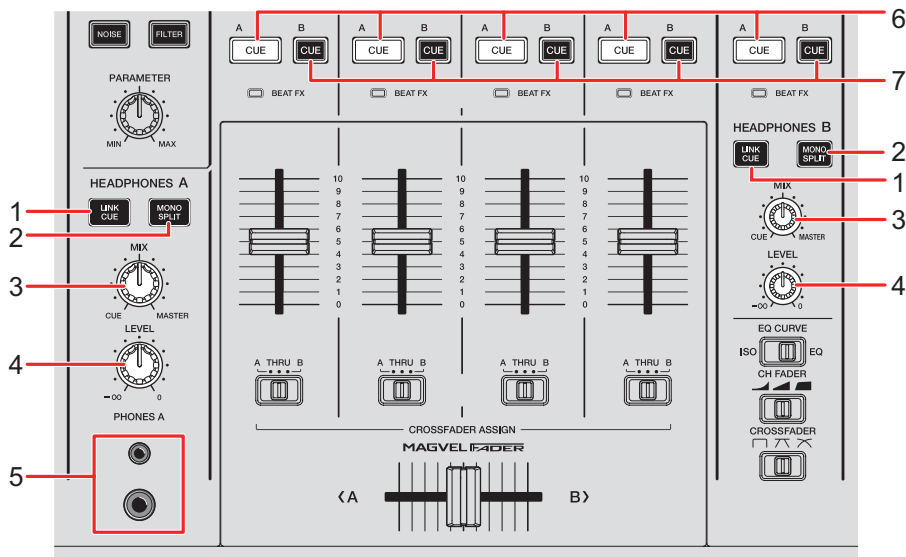

- 1. LINK CUE button**  
Outputs the LINK MONITOR sound.
- 2. MONO SPLIT button**  
Sets the sound output method (MONO SPLIT or stereo) for the headphones.  
Outputs the sound of the channel with the [CUE A]/[CUE B] button pressed to the left channel of your headphones, and the master sound to the right channel when the button is lit.  
Outputs the stereo sound of the channel with the [CUE A]/[CUE B] button pressed when the button isn't lit.
- 3. MIX knob**  
Adjusts the volume balance between the channel with the [CUE] button pressed and the master sound.
- 4. LEVEL knob**  
Adjusts the volume for the headphones monitor sound.
- 5. PHONES A terminals**  
Connect headphones.

- For monitoring sound with **[HEADPHONES B]**, connect headphones to the **[PHONES B]** terminals on the front panel (page 22).
6. **CUE A button**  
Outputs sound to the **[PHONES A]** terminals.
  7. **CUE B button**  
Outputs sound to the **[PHONES B]** terminals.

---

---

## Monitoring with headphones

- 1 **Connect headphones to the [PHONES A] or [PHONES B] terminal.**
  - 2 **Press the [CUE] button ([CUE A], [CUE B] or [LINK CUE]) to select the sound you want to monitor.**
  - 3 **Press the [MONO SPLIT] button of [HEADPHONES A] or [HEADPHONES B] to set the sound output method (MONO SPLIT or stereo).**
  - 4 **Turn the [MIX] knob to adjust the volume balance between the channel with the [CUE] button pressed and the master sound.**
  - 5 **Turn the [LEVEL] knob to adjust the volume for the channel with the [CUE] button pressed.**
- Press the **[CUE]** button again to turn off monitoring.



---

## Booth section

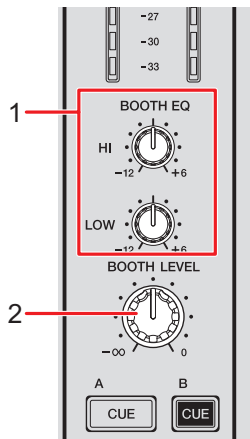

### 1. **BOOTH EQ (HI, LOW) knobs**

Adjusts the volume of each band.

Each knob adjusts in the following range.

— **[HI]**: -12 dB to +6 dB

— **[LOW]**: -12 dB to +6 dB

### 2. **BOOTH LEVEL knob**

Adjusts the volume for the sound output to a booth monitor.

---

## Using a booth monitor

### 1 **Connect a booth monitor to the [BOOTH] terminals.**

➡ Read more: [Connecting to the output terminals \(page 21\)](#)

### 2 **Turn the [BOOTH LEVEL] knob to adjust the volume for the output sound.**

### 3 **Turn the [BOOTH EQ (HI, LOW)] knobs to adjust the sound.**

---

---

# Microphone

---

---

## MIC section

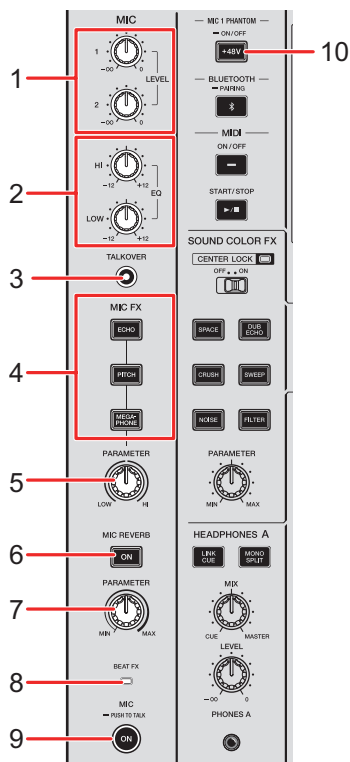

### 1. LEVEL (1, 2) knobs

Adjusts the volume of sound input from the [MIC 1] and [MIC 2] terminals.

### 2. EQ (HI, LOW) knobs

Adjusts the volume of sound input from the [MIC 1] and [MIC 2] terminals.

Each knob adjusts in the following range.

- [HI]: -12 dB to +12 dB
- [LOW]: -12 dB to +12 dB

### 3. TALKOVER button

Turns microphone talkover on and off. The button lights up when it's turned on.

- When sound is input to the microphone, the volume other than the microphone channel is attenuated.

- You can change the talkover mode setting and attenuation level in **[TALKOVER]** in **[MY SETTINGS]** (page 80).

#### 4. **MIC FX buttons**

Select an effect to apply to the microphone sound. The selected button lights up.

- **[ECHO]**: Outputs a delay sound several times while attenuating it to add an echo effect.
- **[PITCH]**: Changes the pitch of the microphone sound.
- **[MEGAPHONE]**: Changes the microphone sound so it sounds like you're talking through a megaphone.

#### 5. **MIC FX PARAMETER knob**

Adjusts the quantitative parameters for the effect selected with the **[MIC FX]** button.

#### 6. **MIC REVERB button**

Turns the microphone reverb on and off. The button lights up when it's turned on.

#### 7. **MIC REVERB PARAMETER knob**

Adjusts the quantitative parameters for the reverb applied to the microphone sound.

#### 8. **BEAT FX indicator**

Lights up when the **[CH SELECT]** button in the Beat FX section is set to **[MIC]**, and blinks when Beat FX is applied to the microphone sound.

#### 9. **MIC button**

Turn the microphone on and off. The button lights up when it's turned on.

- If you press and hold the button, the microphone turns on while the button is pressed and turns off when the button is released (Push-to-talk function).

#### 10. **MIC 1 PHANTOM ON/OFF button**

Press and hold to turn phantom power on and off. The button lights up when it's turned on and DC+48 V phantom power is supplied to the XLR plug of the **[MIC 1]** terminal.

- Turn phantom power on when you use a condenser microphone.
- If the button doesn't light up when it's turned on, the phantom power function is locked. You can unlock it with **[MIC PHANTOM LOCK]** in the Utility settings (page 78).

## CAUTION

Do not turn phantom power on except when you have a condenser microphone that requires phantom power connected to the **[MIC 1]** terminal.

Turn phantom power off before connecting or disconnecting a microphone to/from the **[MIC 1]** terminal. If used improperly, the unit may be damaged.

Only turn phantom power on or off when the **[MIC]** button is turned off or when the **MIC [LEVEL 1]** knob is set to the minimum. If phantom power is used improperly, the monitor device may generate a large amount of noise, which may cause device failure or even hearing loss.

---

---

## Using a microphone

### 1 Connect a microphone to the **[MIC 1]** or **[MIC 2]** terminal.

 Read more: Connecting to the input terminals (page 20)

### 2 Press the **[TALKOVER]** button to turn the microphone talkover on or off.

### 3 Press the **[MIC]** button to turn the microphone on or off.

### 4 Turn the **[LEVEL 1]** or **[LEVEL 2]** knob to adjust the microphone volume level.

- Note that turning the knob too far clockwise outputs the sound at a high volume.

### 5 Turn the **[EQ (HI, LOW)]** knobs to adjust the volume of each band.

### 6 Speak into the microphone.

### 7 To add an effect to the microphone sound, press one of the **[MIC FX]** buttons.

- 8 Turn the [MIC FX PARAMETER] knob to adjust the quantitative parameter for the microphone effect.**
  - 9 To apply reverb to the microphone sound, press the [MIC REVERB] button.**
  - 10 Turn the [MIC REVERB PARAMETER] knob to adjust the quantitative parameter for the reverb.**
-  To add BEAT FX to the microphone sound, see Beat FX section (page 47).

---

---

# Sound Color FX

You can apply a filter or an effect to the sound on any channel.

---

---

## Sound Color FX section

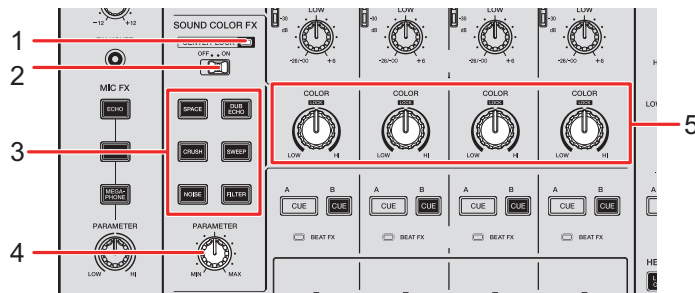

1. **CENTER LOCK indicator**

Lights up when the [CENTER LOCK] switch is set to [ON].

2. **CENTER LOCK switch**

Locks the [COLOR] knob when it's quickly turned up to the center position when this switch is set to [ON]. The lock is released when you release the knob, then you can turn the knob freely.

3. **SOUND COLOR FX buttons**

Selects a Sound Color FX. The selected button blinks.

4. **PARAMETER knob**

Adjusts a quantitative parameter for the effect.

5. **COLOR knob**

Adjusts an effect.

---

## Using Sound Color FX

➡ Read more: Sound Color FX types and settings (page 40)

### 1 Press the [SOUND COLOR FX] button of an effect.

The selected button blinks.

- The selected effect is applied to CH 1 to CH 4.
- If a Sound Color FX was already selected, the effect switches to the one pressed most recently.

### 2 Turn the [COLOR] knob to adjust the effect.

The effect on the channel you turned the knob for is adjusted.

### 3 Turn the [PARAMETER] knob to adjust the quantitative parameter of the effect.

- Press the [SOUND COLOR FX] button of the effect you're using again to turn the effect off.

---

## Sound Color FX types and settings

You can adjust the following settings with the knobs.

Effect/operation	Description
<b>SPACE</b>	Adds reverberation.
<ul style="list-style-type: none"> <li>• <b>COLOR:</b></li> </ul>	<p>Turn counterclockwise to add reverberation to the middle frequency range and low frequency range.</p> <p>Turn clockwise to add reverberation to the middle frequency range and high frequency range.</p>
<ul style="list-style-type: none"> <li>• <b>PARAMETER:</b></li> </ul>	Feedback
<b>DUB ECHO</b>	Adds reverberating echo by outputting the sounds slightly delayed from the original sound several times and attenuating them.
<ul style="list-style-type: none"> <li>• <b>COLOR:</b></li> </ul>	<p>Turn counterclockwise to add reverberating echo to the middle frequency range.</p> <p>Turn clockwise to add reverberating echo to the high frequency range.</p>
<ul style="list-style-type: none"> <li>• <b>PARAMETER:</b></li> </ul>	Feedback
<b>SWEEP</b>	Adds a notch filter effect or a bandpass filter effect.
<ul style="list-style-type: none"> <li>• <b>COLOR:</b></li> </ul>	<p>Turn counterclockwise to gradually increase the bandwidth of the notch filter.</p> <p>Turn clockwise to gradually narrow the bandwidth of the bandpass filter.</p>
<ul style="list-style-type: none"> <li>• <b>PARAMETER:</b></li> </ul>	Center frequency of the filter

---



Effect/operation	Description
<b>NOISE</b>	Outputs filtered white noise mixed with the sound of the channel.
<ul style="list-style-type: none"> <li>• <b>COLOR:</b></li> </ul>	<p>Turn counterclockwise to lower the cut-off frequency for the filter which passes white noise through.</p> <p>Turn clockwise to raise the cut-off frequency for the filter which passes white noise through.</p>
<ul style="list-style-type: none"> <li>• <b>PARAMETER:</b></li> </ul>	Volume of the noise
<ul style="list-style-type: none"> <li>• <b>EQ/ISO (HI, MID, LOW):</b></li> </ul>	Noise quality
<b>CRUSH</b>	Outputs a 'crushed' version of the original sound.
<ul style="list-style-type: none"> <li>• <b>COLOR:</b></li> </ul>	<p>Turn counterclockwise to output the crush sound.</p> <p>Turn clockwise to pass the crush sound through the high-pass filter.</p>
<ul style="list-style-type: none"> <li>• <b>PARAMETER:</b></li> </ul>	Crush effect
<b>FILTER</b>	Outputs filtered sound.
<ul style="list-style-type: none"> <li>• <b>COLOR:</b></li> </ul>	<p>Turn counterclockwise to lower the cut-off frequency of the low-pass filter.</p> <p>Turn clockwise to raise the cut-off frequency of the high-pass filter.</p>
<ul style="list-style-type: none"> <li>• <b>PARAMETER:</b></li> </ul>	Resonance

# Multi I/O

You can route the effect sound of an external effects unit or a mobile device (running an FX application) to the channels or the master output.

Insert method and Return method are supported.

- **Insert method:** Replaces the original sound with the effect sound.

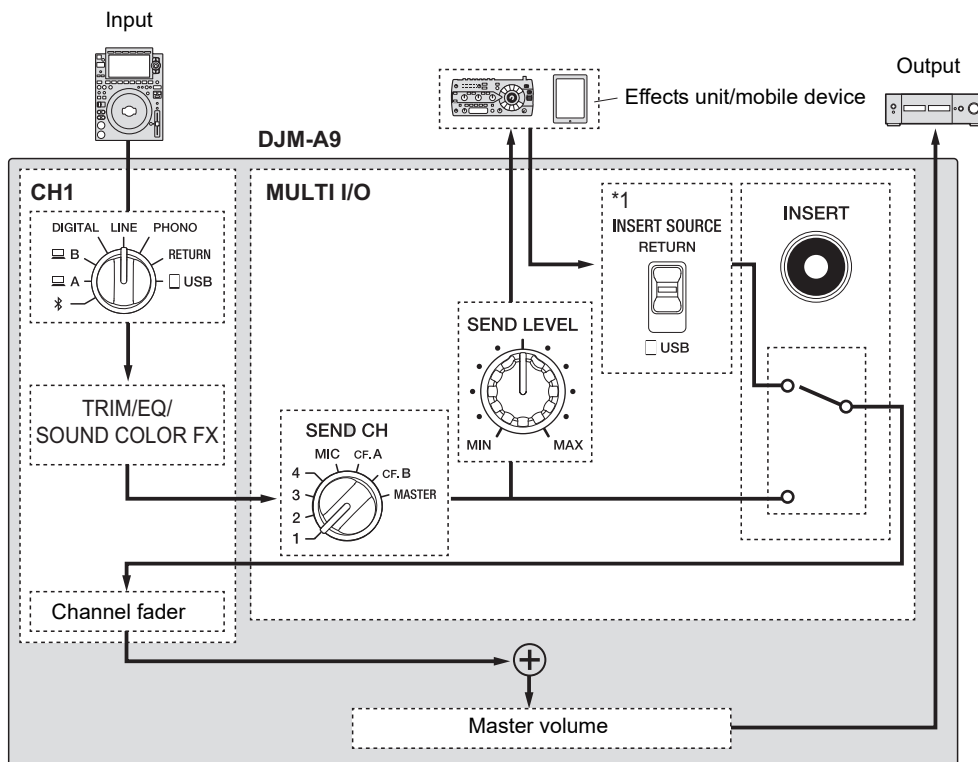

\*1 Selects the sound to mix with the master sound. The sound returned from an external effects unit is output when [RETURN] is selected, and the sound returned from a mobile device is output when [  USB ] is selected.

- **Return method:** Routes the effect sound to a channel separate from the one with the original sound. You can then mix the original sound and the effect sound using the two channels.

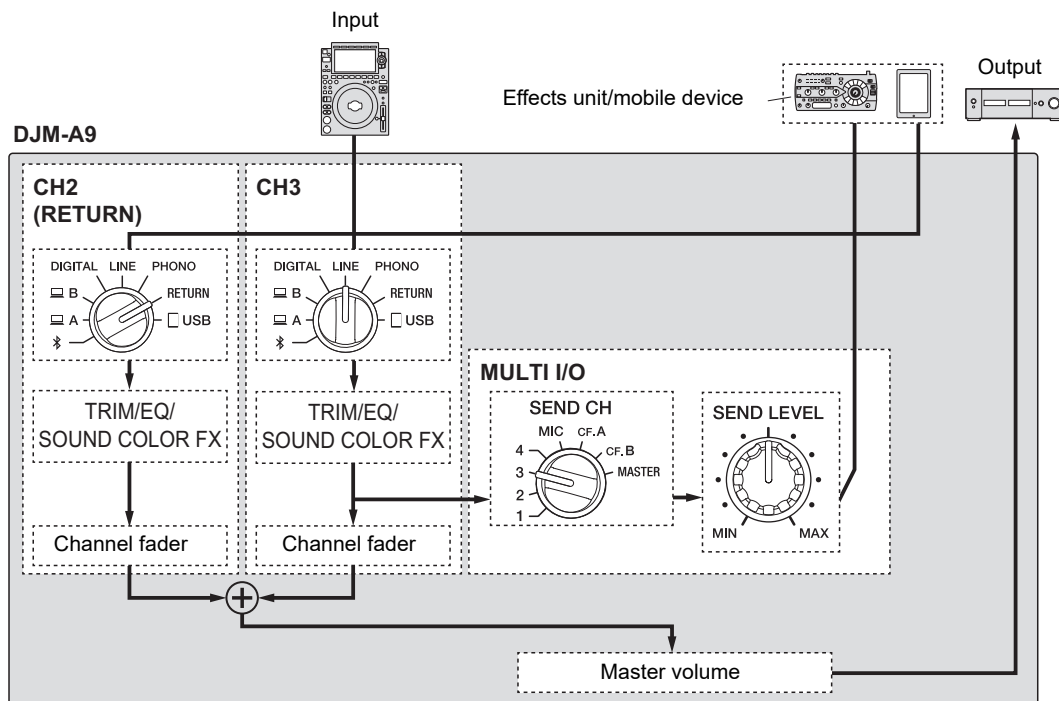

- ➡ For details on connections, see Connecting to the MULTI I/O terminals (page 23).

## MULTI I/O section

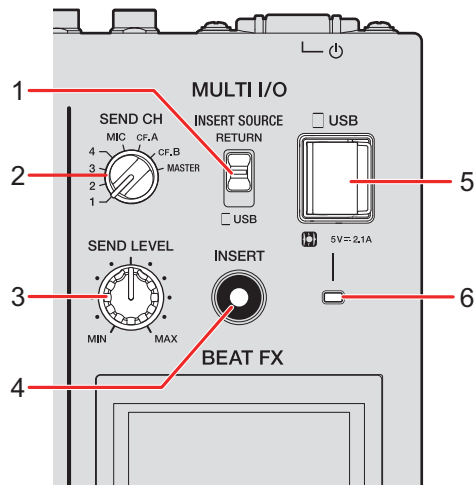

### 1. INSERT SOURCE selector switch

Selects a source of input sound for when using the Insert method.

- **[RETURN]**: Inputs sound from the **[RETURN]** terminals.
- **[USB]**: Inputs sound from the mobile device connection terminal.

### 2. SEND CH selector switch

Selects a channel to add the MULTI I/O effect to.

### 3. SEND LEVEL knob

Adjusts the send level for MULTI I/O.

### 4. INSERT button

Turns the Insert method on and off. The button blinks when it's turned on.

### 5. Mobile device connection terminal (USB port)

Connect a mobile device.

### 6. USB connection indicator

Lights up when a compatible mobile device is connected, and blinks when an incompatible mobile device is connected.

---

## Using Multi I/O

### 1 According to the method you use, set the **[INSERT SOURCE]** selector switch or the input selector switch for each channel.

- When you use the Insert method:
  - If using an external effects unit: Set the **[INSERT SOURCE]** selector switch to **[RETURN]**.
  - If using a mobile device: Set the **[INSERT SOURCE]** selector switch to **[USB]**.
- When you use the Return method:
  - If using an external effects unit: Set the input selector switch for each channel to **[RETURN]**.
  - If using a mobile device: Set the input selector switch for each channel to **[USB]**.

➡ Read more: Channel section/master section/fader curve section (page 24)

### 2 Turn the **[SEND CH]** selector switch to select a channel to add the **MULTI I/O** effect to.

### 3 When using the Insert method, press the **[INSERT]** button to turn it on.

### 4 Turn the **[SEND LEVEL]** knob to adjust the send level for **MULTI I/O**.

- Press the **[INSERT]** button again to turn the Insert method off.
- **MULTI I/O** turns off automatically in the following situations:
  - A channel from **[1]** to **[4]** is selected with the **[SEND CH]** selector switch, and **[RETURN]** is selected with the input selector switch for the selected channel.
  - **[CF.A]** (crossfader A) or **[CF.B]** (crossfader B) is selected with the **[SEND CH]** selector switch, **[RETURN]** is selected with the input selector switch for the selected channel, and the settings selected with the **[CROSSFADER ASSIGN (A, THRU, B)]** selector switch and the **[SEND CH]** selector switch are same.
  - **[MASTER]** is selected with the **[SEND CH]** selector switch, and **[RETURN]** is selected with the input selector switch for any channel.

---

---

# Beat FX

You can add various effects according to the tempo (BPM = Beats Per Minute) of the track being played.

If you use the Quantize function in PRO DJ LINK, the unit adds effects by automatically synchronizing it with the beat according to the track's grid information analyzed by rekordbox. This happens even if you operate the **[ON/OFF]** button in the Beat FX section and X-PAD roughly.

- To use the Quantize function in PRO DJ LINK, connect a PRO DJ LINK compatible multi player from Pioneer DJ to the unit.  
Analyze the tracks in rekordbox beforehand. For details on track analysis, see the rekordbox Instruction Manual (page 6).

 Read more: PRO DJ LINK (page 7)

# Beat FX section

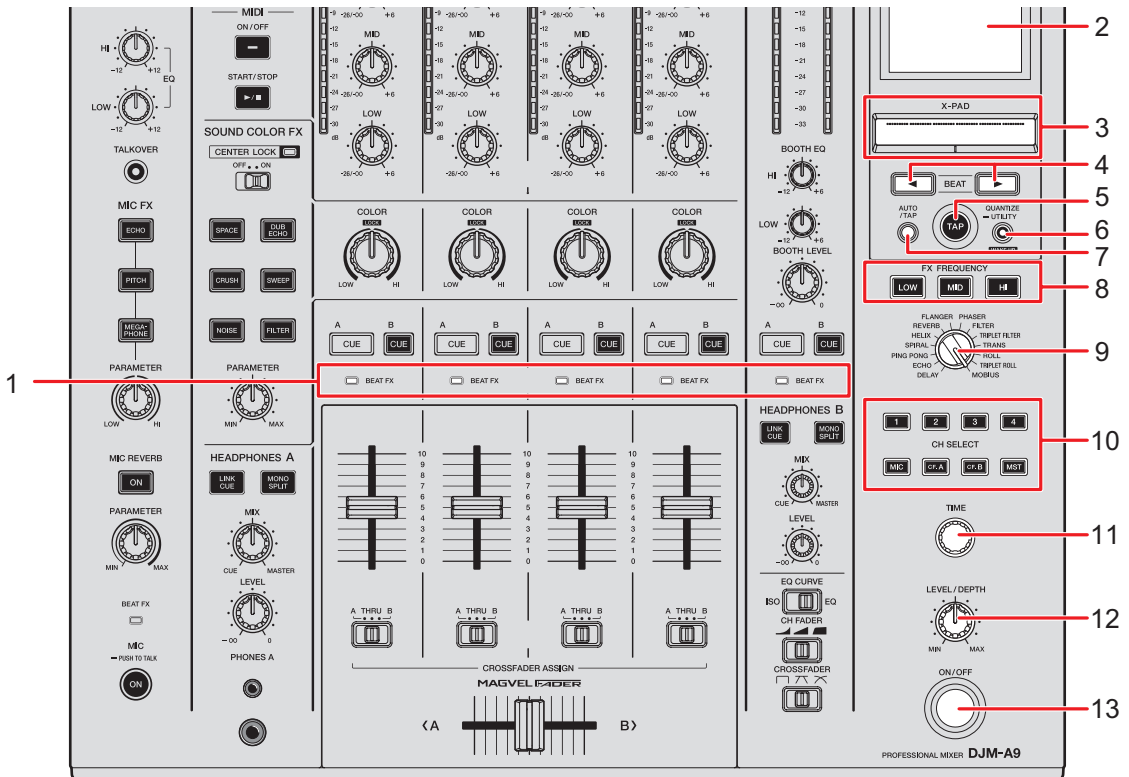

## 1. BEAT FX indicator

The Beat FX indicator of the channel selected with the [CH SELECT] button lights up, and blinks when Beat FX is being applied.

## 2. Screen display (page 49)

## 3. X-PAD

Touch to turn the effect on, and release to turn the effect off.

Touch and slide your finger on the pad to adjust the time/quantitative parameter for the effect.

## 4. BEAT ◀▶ buttons

Sets the number of beats for Beat FX.

## 5. TAP button

Tap to manually set a BPM.

## 6. QUANTIZE/UTILITY (WAKE UP) button

Press to turn Quantize on and off. The button lights up when it's turned on.

- Press during standby mode to exit standby mode.

- Press and hold to display the [UTILITY] screen (page 75).

## 7. **AUTO/TAP button**

Selects the BPM measuring method (AUTO/TAP). The selected method is displayed on the screen.

- AUTO: Automatically measures BPM of the input sound (measuring range: 70 to 180).
- TAP: Manually sets a BPM (page 51).

- AUTO is automatically set when you turn the unit on.

## 8. **FX FREQUENCY (LOW, MID, HI) buttons**

Selects the range ([LOW]/[MID]/[HI]) to apply Beat FX to. The selected button lights up.

## 9. **BEAT FX selector switch**

Selects a Beat FX.

## 10. **CH SELECT button**

Selects a channel to apply a Beat FX to. The selected button lights up.

## 11. **TIME knob** (page 52)

## 12. **LEVEL/DEPTH knob** (page 52)

- Turning all the way counterclockwise outputs the original sound.

## 13. **ON/OFF button**

Turns Beat FX on and off. The button blinks when it's turned on.



## Screen display

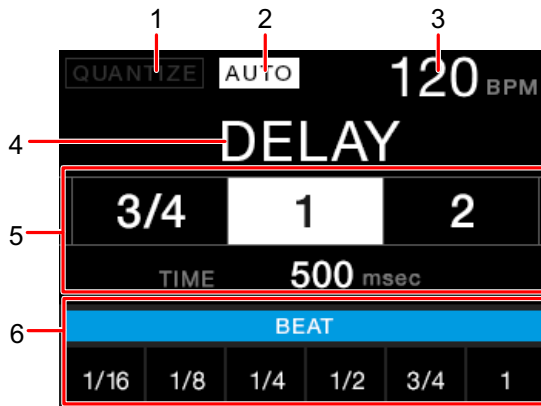

### 1. QUANTIZE

Indicates the status of the QUANTIZE function as follows.

- Lights up in red: QUANTIZE is turned on.
  - Lights up in gray: QUANTIZE is turned on but the unit isn't receiving the GRID information.
  - Not displayed: QUANTIZE is turned off.
- The unit may not receive the GRID information depending on the playback status of a connected multi player (e.g. if it's off air, scratching, playing in reverse, etc.).

### 2. AUTO/TAP

Displays [AUTO] when in automatic BPM measuring mode, and [TAP] when in manual BPM input mode.

- The BPM value blinks when it can't be measured correctly in the [AUTO] setting. Use the [TAP] mode if this happens.

### 3. BPM value

### 4. Effect name

Displays the name of the selected effect.

### 5. Beat/parameter

Lights up the selected number of beat and displays the time corresponding to the number of beat.

- For some effects, you can display parameters by pressing the [BEAT ◀] or [BEAT ▶] button. The display blinks if the number out of the parameter range is set.

### 6. X-PAD status

Displays the operation position on the X-PAD.

---

## Using Beat FX

➤ Read more: Beat FX types and settings (page 52)

**1 Press the [AUTO/TAP] or [QUANTIZE/UTILITY (WAKE UP)] button to set the BPM measuring mode.**

**2 Turn the Beat FX selector switch to select an effect.**

The display for the selected Beat FX appears.

**3 Press the [CH SELECT] button for the channel to apply the effect to.**

**4 Press the [BEAT ◀] or [BEAT ▶] button to set a beat fraction to synchronize the effect with.**

**5 Press the [FX FREQUENCY (LOW, MID, HI)] button to select the range to apply the effect to.**

**6 Turn the [TIME] and [LEVEL/DEPTH] knobs to adjust parameters for the effect.**

**7 Press the [ON/OFF] button (or touch the X-PAD) to turn Beat FX on.**

The selected effect is applied to the sound of the channel selected with the [CH SELECT] button.

- Press the [ON/OFF] button again to turn Beat FX off.

---

## Setting the BPM manually

### 1 Tap the [TAP] button more than twice in time with the beat of the track.

The BPM is set according to the average time between taps.

- The beat fraction is set to [1/1] when you set the BPM with the [TAP] button, and the length of one beat is set as the effect time.
- You can also set the BPM manually by turning the [TIME] knob while pressing the [TAP] button.
- Turn the [TIME] knob while pressing the [TAP] and [AUTO/TAP] buttons, or press the [BEAT ◀] or [BEAT ▶] button while pressing the [TAP] button to set the BPM in increments of 0.1.

## Beat FX types and settings

You can adjust the following BEAT FX settings with the relevant buttons and knobs, etc.

BEAT FX/controls	Descriptions
<b>DELAY</b> <sup>1</sup> <sup>2</sup>	Outputs a delay sound once according to the beat.
<ul style="list-style-type: none"> <li>• <b>BEAT</b> ◀/▶:</li> <li>• <b>TIME</b>:</li> <li>• <b>LEVEL/DEPTH</b>:</li> <li>• <b>X-PAD</b>:</li> </ul>	<p>Delay time with respect to 1 beat of the BPM (beat fraction): 1/16 to 16 beats</p> <p>Delay time: 1 to 4000 (ms)</p> <p>Balance between the original sound and the effect sound</p> <p>Delay time</p>
<b>ECHO</b> <sup>1</sup> <sup>2</sup>	Outputs a delay sound several times while attenuating it according to the beat.
<ul style="list-style-type: none"> <li>• <b>BEAT</b> ◀/▶:</li> <li>• <b>TIME</b>:</li> <li>• <b>LEVEL/DEPTH</b>:</li> <li>• <b>X-PAD</b>:</li> </ul>	<p>Delay time with respect to 1 beat of the BPM (beat fraction): 1/16 to 16 beats</p> <p>Delay time: 1 to 4000 (ms)</p> <p>Balance between the original sound and the effect sound</p> <p>Delay time</p>
<b>PING PONG</b> <sup>1</sup> <sup>2</sup>	Outputs a delay sound with different delay times for the left and right several times while attenuating it according to the beat, producing a stereo-like effect.
<ul style="list-style-type: none"> <li>• <b>BEAT</b> ◀/▶:</li> <li>• <b>TIME</b>:</li> <li>• <b>LEVEL/DEPTH</b>:</li> <li>• <b>X-PAD</b>:</li> </ul>	<p>Delay time with respect to 1 beat of the BPM (beat fraction): 1/16 to 16 beats</p> <p>Delay time: 10 to 4000 (ms)</p> <p>Balance between the original sound and the effect sound</p> <p>Delay time</p>

BEAT FX/controls	Descriptions
<p><b>SPIRAL</b> <span>1</span> <span>2</span></p> <ul style="list-style-type: none"> <li>• <b>BEAT</b> ◀/▶: Delay time with respect to 1 beat of the BPM (beat fraction): 1/16 to 16 beats</li> <li>• <b>TIME:</b> Delay time: 10 to 4000 (ms)</li> <li>• <b>LEVEL/DEPTH:</b> Balance between the original sound and the effect sound, and feedback</li> <li>• <b>X-PAD:</b> Delay time</li> </ul>	<p>Adds reverberation to the input sound.</p>
<p><b>HELIX</b></p> <ul style="list-style-type: none"> <li>• <b>BEAT</b> ◀/▶: Effect time with respect to 1 beat of the BPM (beat fraction): 1/16 to 16 beats</li> <li>• <b>TIME:</b> Effect time: 10 to 4000 (ms)</li> <li>• <b>LEVEL/DEPTH:</b> Ratio of sound overlay           <ul style="list-style-type: none"> <li>• You can change the attenuation rate by turning the [LEVEL/DEPTH] knob all the way counterclockwise and then clockwise. Turn the knob all the way clockwise to fix the output sound.</li> </ul> </li> <li>• <b>X-PAD:</b> Effect time</li> </ul>	<p>Records the input sound, and outputs the recorded sound repeatedly according to the specified beat fraction.</p>
<p><b>REVERB</b> <span>1</span> <span>2</span></p> <ul style="list-style-type: none"> <li>• <b>BEAT</b> ◀/▶: Reverberation level: 1 to 100%</li> <li>• <b>TIME:</b> Reverberation level: 1 to 100%</li> <li>• <b>LEVEL/DEPTH:</b> Balance between the original sound and the effect sound</li> <li>• <b>X-PAD:</b> Cut-off frequency for the filter</li> </ul>	<p>Adds reverberation to the input sound.</p>

BEAT FX/controls	Descriptions
<b>FLANGER</b>	Adds a cyclic flanger effect according to the beat.
• <b>BEAT</b> ◀/▶:	Moving cycle of the effect with respect to 1 beat of the BPM (beat fraction): 1/16 to 64 beats
• <b>TIME:</b>	Moving cycle of the effect: 10 to 32000 (ms)
• <b>LEVEL/DEPTH:</b>	Effect level
• <b>X-PAD:</b>	Moving cycle of the effect
<b>PHASER</b>	Adds a cyclic phaser effect according to the beat.
• <b>BEAT</b> ◀/▶:	Moving cycle of the effect with respect to 1 beat of the BPM (beat fraction): 1/16 to 64 beats
• <b>TIME:</b>	Moving cycle of the effect: 10 to 32000 (ms)
• <b>LEVEL/DEPTH:</b>	Effect level
• <b>X-PAD:</b>	Moving cycle of the effect
<b>FILTER</b>	Changes the cut-off frequency cyclically for the filter according to the beat.
• <b>BEAT</b> ◀/▶:	Moving cycle of the effect with respect to 1 beat of the BPM (beat fraction): 1/16 to 64 beats
• <b>TIME:</b>	Moving cycle of the effect: 10 to 32000 (ms)
• <b>LEVEL/DEPTH:</b>	Effect level
• <b>X-PAD:</b>	Moving cycle of the effect

BEAT FX/controls	Descriptions
<p><b>TRIPLET FILTER</b></p> <ul style="list-style-type: none"> <li>• <b>BEAT ◀/▶:</b></li> <li>• <b>TIME:</b></li> <li>• <b>LEVEL/DEPTH:</b></li> <li>• <b>X-PAD:</b></li> </ul>	<p>Changes the cut-off frequency cyclically for the filter according to the beat (based on 3 beats).</p> <p>Moving cycle of the effect with respect to 1 beat of the BPM (beat fraction): 1/12 to 12/3 beats</p> <p>Moving cycle of the effect: 10 to 32000 (ms)</p> <p>Effect level</p> <p>Moving cycle of the effect</p>
<p><b>TRANS</b></p> <ul style="list-style-type: none"> <li>• <b>BEAT ◀/▶:</b></li> <li>• <b>TIME:</b></li> <li>• <b>LEVEL/DEPTH:</b></li> <li>• <b>X-PAD:</b></li> </ul>	<p>Cuts the sound cyclically according to the beat.</p> <p>Cycle of the cut with respect to 1 beat of the BPM (beat fraction): 1/16 to 16 beats</p> <p>Effect time: 10 to 16000 (ms)</p> <p>Balance between the original sound and the effect sound, and duty</p> <p>Cut cycle</p>
<p><b>ROLL</b></p> <ul style="list-style-type: none"> <li>• <b>BEAT ◀/▶:</b></li> <li>• <b>TIME:</b></li> <li>• <b>LEVEL/DEPTH:</b></li> <li>• <b>X-PAD:</b></li> </ul>	<p>Records the input sound when the [ON/OFF] button is pressed, and outputs the recorded sound repeatedly according to the specified beat fraction.</p> <p>Effect time with respect to 1 beat of the BPM (beat fraction): 1/16 to 16 beats</p> <p>Effect time: 10 to 4000 (ms)</p> <p>Balance between the original sound and the effect sound</p> <p>Effect time</p>

BEAT FX/controls	Descriptions
<p><b>TRIPLET ROLL</b></p> <ul style="list-style-type: none"> <li>• <b>BEAT ◀/▶:</b></li> <li>• <b>TIME:</b></li> <li>• <b>LEVEL/DEPTH:</b></li> <li>• <b>X-PAD:</b></li> </ul>	<p>Records the input sound when the [ON/OFF] button is pressed, and outputs the recorded sound repeatedly according to the specified beat fraction (based on 3 beats).</p> <p>Cycle of the effect with respect to 1 beat of the BPM (beat fraction): 1/12 to 12/3 beats</p> <p>Effect time: 10 to 4000 (ms)</p> <p>Balance between the original sound and the effect sound</p> <p>Effect time</p>
<p><b>MOBIUS</b></p> <ul style="list-style-type: none"> <li>• <b>BEAT ◀/▶:</b></li> <li>• <b>TIME:</b></li> <li>• <b>LEVEL/DEPTH:</b></li> <li>• <b>X-PAD:</b></li> </ul>	<p>Changes the frequency of the sounding oscillator to keep rising or falling in time with the beat.</p> <p>Moving cycle of the effect with respect to 1 beat of the BPM (beat fraction): 1/16 to 64 beats/-64 to -1/16 beats</p> <p>Moving cycle of the effect: 10 to 32000/-32000 to -10 (ms)</p> <p>Volume of the oscillator</p> <p>Waveform of the oscillator</p>

<sup>1</sup> If the [CH SELECT] button is set to [1] to [4], you can't monitor the effect sound, even if you press the [CUE A] or [CUE B] button for the relevant channel.

<sup>2</sup> Only the effect sound remains if you set the channel fader to the [0] position to cut the input sound.



---

---

# USB/MIDI

If you connect a PC/Mac or mobile device with MIDI software installed, to the unit via a USB cable, you can control the DJ software via the unit.

- For details on the unit's MIDI messages, visit the URL below.

[pioneerdj.com/support/](http://pioneerdj.com/support/)

- Set the MIDI channel for outputting MIDI in [MIDI] in [MY SETTINGS]. You don't need to make the setting to output via HID.



---

---

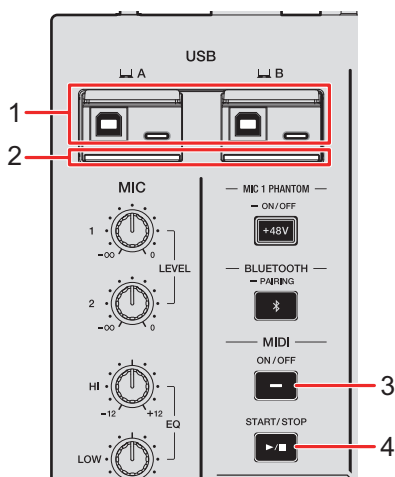
## USB/MIDI section



### 1. A, B (USB) ports (page 22)

- If devices are connected to the Type-B and Type-C ports in [ A] or [ B] at the same time, they can't be used simultaneously. The port first connected with a device will be active and the other port will be inactive (the USB indicator turns off).

### 2. USB connection indicator

Blinks when a PC/Mac is connected, and slowly blinks when a PC/Mac without the dedicated software installed is connected.

- To input or output your PC/Mac's audio to/from the unit, install the dedicated software on your computer (page 13).

### 3. **MIDI ON/OFF button**

Turns MIDI on and off. The button lights up when it's turned on.

### 4. **MIDI START/STOP button**

Sends the MIDI start/stop messages. The button lights up after the start message is sent, and turns off after the stop message is sent.



---

---

## Controlling MIDI software

- Install MIDI software and configure the audio and MIDI settings on a PC/Mac or mobile device beforehand.

### 1 **Connect a PC/Mac or mobile device to the unit.**

- Connect a PC/Mac to the [  **A** ] or [  **B** ] (USB) port, or connect a mobile device to the mobile device connection terminal in the MULTI I/O section (page 22).

### 2 **Launch the MIDI software.**

- This completes the sequence if you're using a mobile device.

### 3 **Press the [MIDI ON/OFF] button to turn MIDI on.**

The sending of MIDI messages starts.

- Press the [MIDI ON/OFF] button again to turn MIDI off and stop sending MIDI messages.
- The MIDI timing clock (BPM) is sent even when the [MIDI ON/OFF] button is switched off.
- Press the [MIDI START/STOP] button to send the MIDI start and stop messages alternately. The messages are sent even when the [MIDI ON/OFF] button is switched off.

---

---

# Bluetooth

You can input the sound of your PC/Mac or mobile device to the unit via Bluetooth.

- Connect and adjust the wireless antenna when you use Bluetooth (page 63).

---

---

## Bluetooth section

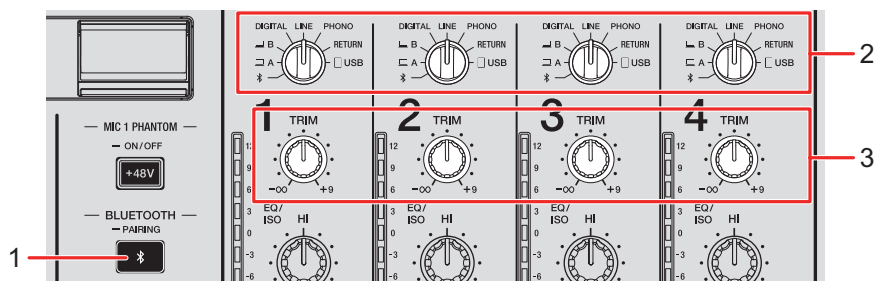

### 1. **BLUETOOTH PAIRING button**

Pairs the unit with a Bluetooth device.

The button indicates the connection status as follows.

- Blinks: The unit is waiting to pair (blinks at regular intervals) or to connect (blinks twice repeatedly).
- Lights up: The unit is connected with a Bluetooth device.

### 2. **Input selector switch** (page 24)

### 3. **TRIM knob** (page 24)

---

## Pairing with a Bluetooth device

### 1 Press and hold the [BLUETOOTH PAIRING] button for approximately 2 seconds.

The unit enters pairing state.

- The Bluetooth indicator blinks while the unit is in pairing state (for approximately 2 minutes).

### 2 Perform the pairing procedure on a Bluetooth device.

The Bluetooth indicator on the unit stops blinking and lights up when the connection is established.

- Perform the pairing procedure on a Bluetooth device while the unit is in pairing state. If the unit can't pair with a Bluetooth device within 2 minutes, the Bluetooth indicator turns off.
- For details on the pairing procedure for the Bluetooth device, refer to the device's instruction manual.
- If you use a Bluetooth device registered to the unit, you can connect the unit with the device by pressing the [BLUETOOTH PAIRING] button briefly.
- You can only connect the unit to 1 Bluetooth device at a time. If the unit pairs with a second device, the registration of the first device will be lost. To register the first device again, perform pairing with the device.

---

## Using a Bluetooth device

- 1 **Connect a Bluetooth device with the unit.**
- 2 **Set the input selector switch for the channel to which Bluetooth audio is input to [ \* ].**
- 3 **Play sound on the Bluetooth device.**
- 4 **Turn the [TRIM] knob for the channel to which Bluetooth audio is input to adjust the volume.**

---

---

# Wireless LAN (Wi-Fi)

By connecting a tablet with the unit via Wi-Fi, you can use the Stagehand app on the tablet to check the status of Pioneer DJ multi players or mixers and remote-control them.

- You can use the Stagehand app (page 8) while using PRO DJ LINK.
- For details, refer to the instruction manuals for the Stagehand app and rekordbox.

[pioneerdj.com/en/product/software/](http://pioneerdj.com/en/product/software/)  
[rekordbox.com/manual](http://rekordbox.com/manual)

- Connect the wireless antenna when you want to use a Bluetooth connection.

---

---

## Connecting and disconnecting the wireless antenna

You can connect and disconnect the wireless antenna to/from the unit.

- The wireless antenna is connected by default.
- Do not connect any antenna other than the one supplied with this unit.
- To prevent damage, disconnect the wireless antenna when you pack away or transport the unit.
- Do not apply excessive force to the wireless antenna, or it may be damaged.
- The wireless antenna bends in one direction. Be sure to check the moving part and bend it in the correct direction.

### ❖ Disconnecting the wireless antenna

#### 1 Straighten the wireless antenna.

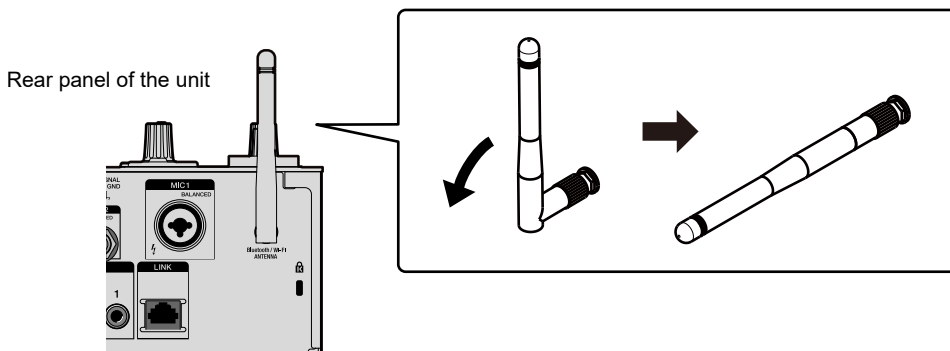

## 2 Turn the knurled part and remove the antenna from the unit.

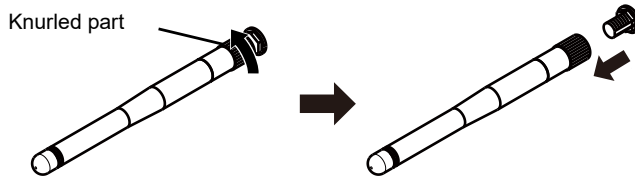

### ❖ Connecting the wireless antenna

## 1 Align the wireless antenna horizontally with the antenna terminal and turn the knurled part to attach it to the unit.

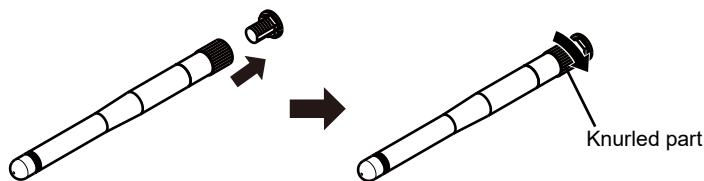

- Turn the knurled part and tighten it firmly (if it's tightened correctly, there will be an approximately 3 mm gap from the base of the mounting part). Be careful not to overtighten it.

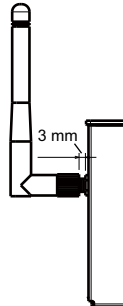

## 2 Turn the wireless antenna and adjust its angle to enable a strong reception.

Rear panel of the unit

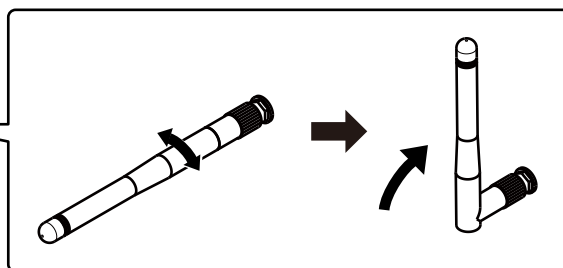
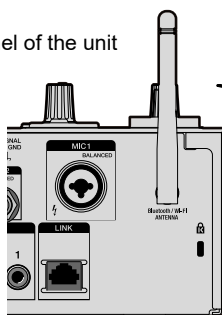

## Setting wireless LAN (Wi-Fi)

- 1 Press and hold the [QUANTIZE/UTILITY (WAKE UP)] button.

The Utility menu appears.

- 2 Turn the [TIME] knob in the Beat FX section or press the [BEAT ◀] or [BEAT ▶] button to select [GENERAL SETTINGS], and press the [TAP] button.

The setting items under [GENERAL SETTINGS] appear.

- 3 Turn the [TIME] knob or press the [BEAT ◀] or [BEAT ▶] button to select [Wi-Fi], and press the [TAP] button.

- 4 Turn the [TIME] knob or press the [BEAT ◀] or [BEAT ▶] button to select [Wi-Fi], and press the [TAP] button.

The Wi-Fi ON/OFF screen appears.

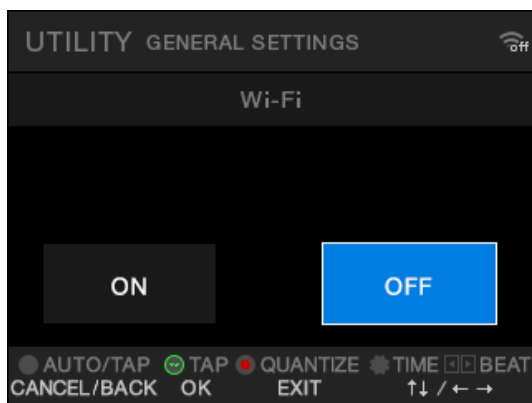

- 5 Turn the [TIME] knob or press the [BEAT ◀] or [BEAT ▶] button to select [ON] or [OFF], and press the [TAP] button.

- When set to [ON], if there is an access point that has connected with the unit previously, the unit is automatically connected to the access point. The factory setting is [OFF].
- The signal strength (icon) of the wireless LAN (Wi-Fi) connection is displayed on the [UTILITY] screen (page 74).



---

## Connecting the unit to a wireless network

You can connect the unit to a wireless network via the following methods:

- Connecting with WPS (page 65)
- Searching for an access point (page 68)
- Specifying an access point (page 70)

---

### Connecting with WPS

You can connect using the PBC method or PIN method.

#### ❖ PBC method

Connect the unit to the wireless router (access point) by pressing the WPS button on the router.

- Use a wireless router that supports WPS (PBC method).

#### 1 Press and hold the [QUANTIZE/UTILITY (WAKE UP)] button.

The Utility menu appears.

#### 2 Turn the [TIME] knob in the Beat FX section or press the [BEAT ◀] or [BEAT ▶] button to select [GENERAL SETTINGS], and press the [TAP] button.

The setting items under [GENERAL SETTINGS] appear.

#### 3 Turn the [TIME] knob or press the [BEAT ◀] or [BEAT ▶] button to select [Wi-Fi], and press the [TAP] button.

#### 4 Turn the [TIME] knob or press the [BEAT ◀] or [BEAT ▶] button to select [CONNECT BY WPS], and press the [TAP] button.

#### 5 Turn the [TIME] knob or press the [BEAT ◀] or [BEAT ▶] button to select [PBC], and press the [TAP] button.

The [CONNECT BY WPS(PBC)] screen appears.

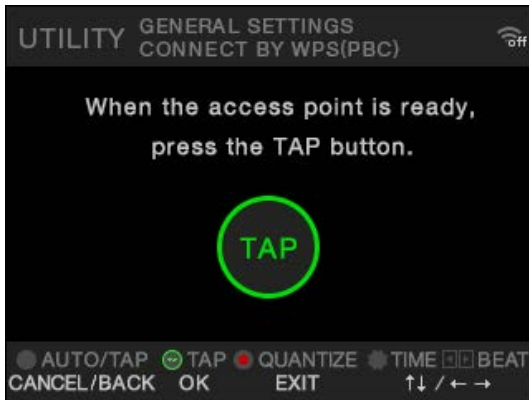

## 6 Press the [TAP] button.

[Connecting...] is displayed.

- Perform the next step within 120 seconds of pressing the [TAP] button.

## 7 Press the WPS button on the wireless router.

If the connection succeeds, [Success] is displayed.

- Refer to the instruction manual of your wireless router and press the WPS button on the wireless router.
- If [Failure] is displayed, perform the procedure from step 1 again, or try other connection methods.

## ❖ PIN method

Connect the unit to the wireless router (access point) by using the PIN code of the unit.

- Use a wireless router that supports WPS (PIN method).

## 1 Press and hold the [QUANTIZE/UTILITY (WAKE UP)] button.

The Utility menu appears.

## 2 Turn the [TIME] knob in the Beat FX section or press the [BEAT ◀] or [BEAT ▶] button to select [GENERAL SETTINGS], and press the [TAP] button.

The setting items under [GENERAL SETTINGS] appear.

- 3 Turn the [TIME] knob or press the [BEAT ◀] or [BEAT ▶] button to select [Wi-Fi], and press the [TAP] button.
- 4 Turn the [TIME] knob or press the [BEAT ◀] or [BEAT ▶] button to select [CONNECT BY WPS], and press the [TAP] button.
- 5 Turn the [TIME] knob or press the [BEAT ◀] or [BEAT ▶] button to select [PIN], and press the [TAP] button.

The PIN code of the unit appears.

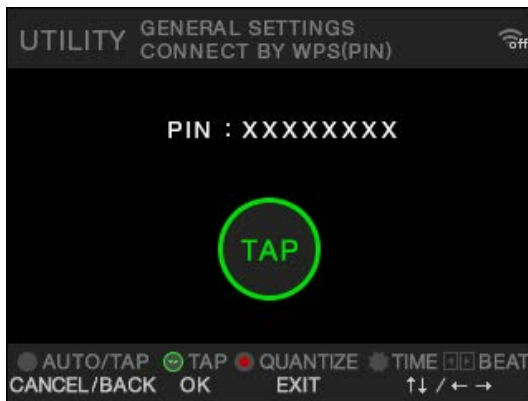

- The PIN code changes each time the screen is displayed.

## 6 Press the [TAP] button.

[Connecting...] is displayed.

- Perform the next step within 120 seconds of pressing the [TAP] button.

## 7 Set the PIN code of the unit in the wireless router.

If the connection succeeds, [Success] is displayed.

- If [Failure] is displayed, perform the procedure from step 1 again, or try other connection methods.
- For details on setting the wireless router to WPS mode, refer to the instruction manual for the wireless router.

---

## Searching for an access point

- 1 Press and hold the [QUANTIZE/UTILITY (WAKE UP)] button.

The Utility menu appears.

- 2 Turn the [TIME] knob in the Beat FX section or press the [BEAT ◀] or [BEAT ▶] button to select [GENERAL SETTINGS], and press the [TAP] button.

The setting items under [GENERAL SETTINGS] appear.

- 3 Turn the [TIME] knob or press the [BEAT ◀] or [BEAT ▶] button to select [Wi-Fi], and press the [TAP] button.

- 4 Turn the [TIME] knob or press the [BEAT ◀] or [BEAT ▶] button to select [CONNECT BY PASSWORD], and press the [TAP] button.

- 5 Turn the [TIME] knob or press the [BEAT ◀] or [BEAT ▶] button to select [SELECT SSID], and press the [TAP] button.

The access points list is displayed.

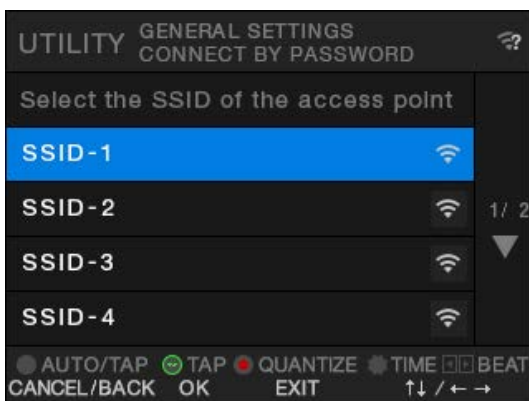

- SSIDs may not be detected depending on the signal strength. In that case, press the [AUTO/TAP] button to return to the previous screen, then navigate to the access points list again.

- 6 Turn the [TIME] knob or press the [BEAT ◀] or [BEAT ▶] button to select an access point, and press the [TAP] button.

The encryption method selection screen appears.

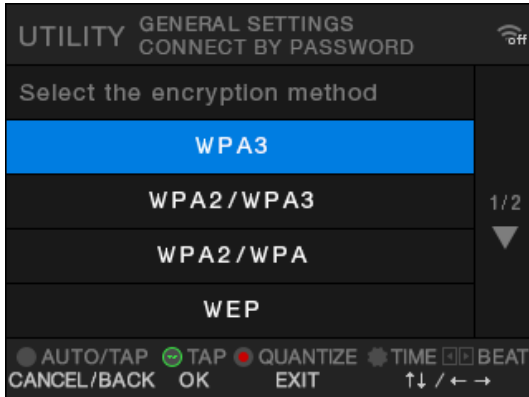

- 7 Turn the [TIME] knob or press the [BEAT ◀] or [BEAT ▶] button to select an encryption method (used in the access point), and press the [TAP] button.

The password (security key) input screen appears.

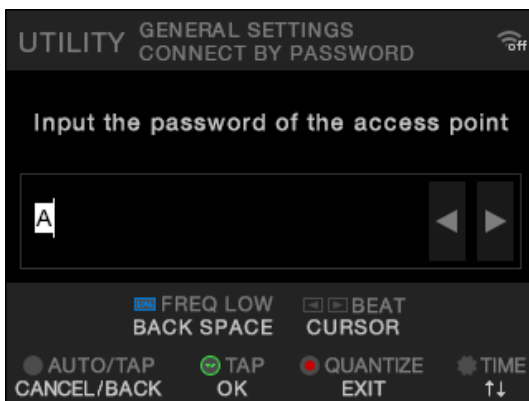

- If you don't know the encryption method, select [AUTO].

- 8 Enter a password (security key), and press the [TAP] button.

[Connecting...] is displayed.

If the connection succeeds, [Success] is displayed.

- Use the [TIME] knob and [BEAT ◀], [BEAT ▶] and [FX FREQUENCY (LOW)] buttons to enter a password (security key).

- If [Failure] is displayed, perform the procedure from step 1 again, or try other connection methods.

---

## Specifying an access point

### 1 Press and hold the [QUANTIZE/UTILITY (WAKE UP)] button.

The Utility menu appears.

### 2 Turn the [TIME] knob in the Beat FX section or press the [BEAT ◀] or [BEAT ▶] button to select [GENERAL SETTINGS], and press the [TAP] button.

The setting items under [GENERAL SETTINGS] appear.

### 3 Turn the [TIME] knob or press the [BEAT ◀] or [BEAT ▶] button to select [Wi-Fi], and press the [TAP] button.

### 4 Turn the [TIME] knob or press the [BEAT ◀] or [BEAT ▶] button to select [CONNECT BY PASSWORD], and press the [TAP] button.

### 5 Turn the [TIME] knob or press the [BEAT ◀] or [BEAT ▶] button to select [MANUAL], and press the [TAP] button.

The SSID specification screen appears.

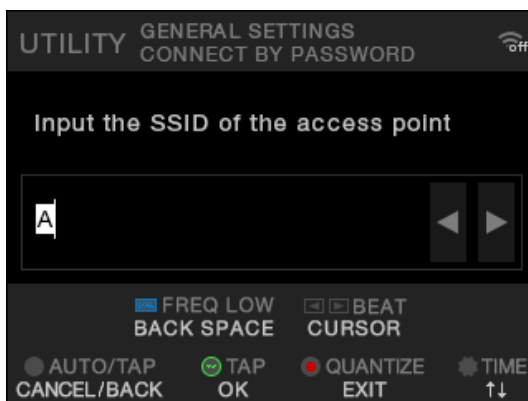

## 6 Enter a network name (SSID), and press the [TAP] button.

The encryption method selection screen appears.

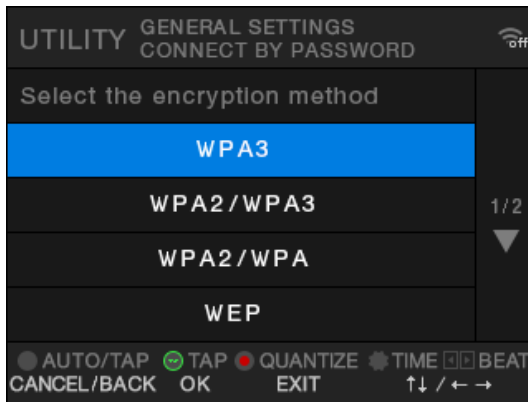

- Use the [TIME] knob and [BEAT ◀], [BEAT ▶] and [FX FREQUENCY (LOW)] buttons to enter a network name (SSID).

## 7 Turn the [TIME] knob or press the [BEAT ◀] or [BEAT ▶] button to select an encryption method (used in the access point), and press the [TAP] button.

The password (security key) input screen appears.

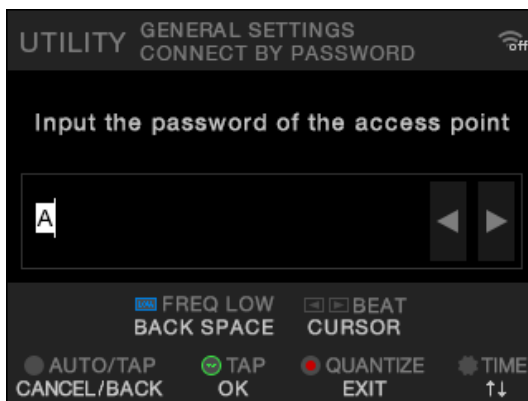

- If you don't know the encryption method, select [AUTO].

## 8 Enter a password (security key), and press the [TAP] button.

[Connecting...] is displayed.

If the connection succeeds, [Success] is displayed.

- Use the [TIME] knob and [BEAT ◀], [BEAT ▶] and [FX FREQUENCY (LOW)] buttons to enter a password (security key).

- If **[Failure]** is displayed, perform the procedure from step 1 again, or try other connection methods.

---

---

## Viewing the Wireless LAN (Wi-Fi) information

### 1 Press and hold the **[QUANTIZE/UTILITY (WAKE UP)]** button.

The Utility menu appears.

### 2 Turn the **[TIME]** knob in the Beat FX section or press the **[BEAT ◀]** or **[BEAT ▶]** button to select **[GENERAL SETTINGS]**, and press the **[TAP]** button.

The setting items under **[GENERAL SETTINGS]** appear.

### 3 Turn the **[TIME]** knob or press the **[BEAT ◀]** or **[BEAT ▶]** button to select **[Wi-Fi]**, and press the **[TAP]** button.

### 4 Turn the **[TIME]** knob or press the **[BEAT ◀]** or **[BEAT ▶]** button to select **[INFORMATION]**, and press the **[TAP]** button.

The SSID, IP address, and MAC address of the wireless LAN are displayed.

- If there is a DHCP server in your network, the DHCP server will give an IP address. If a DHCP server doesn't exist, this unit gives an IP address. It takes time for the unit to give an IP address.



## Viewing the LAN information

- 1 Press and hold the [QUANTIZE/UTILITY (WAKE UP)] button.**

The Utility menu appears.

- 2 Turn the [TIME] knob in the Beat FX section or press the [BEAT ◀] or [BEAT ▶] button to select [GENERAL SETTINGS], and press the [TAP] button.**

The setting items under [GENERAL SETTINGS] appear.

- 3 Turn the [TIME] knob or press the [BEAT ◀] or [BEAT ▶] button to select [LAN], and press the [TAP] button.**

- 4 Press the [TAP] button.**

The IP address and MAC address of the wired LAN are displayed.

- If there is a DHCP server in your network, the DHCP server will give an IP address. If a DHCP server doesn't exist, this unit gives an IP address. It takes time for the unit to give an IP address.
- If a LAN cable isn't connected, the IP address won't be displayed.

---

---

# Settings

You can change the unit's settings in the Utility settings. If you save MY SETTINGS to a storage device (USB drive, etc.), you can load them to the unit immediately when you arrive in the booth or take over from another DJ, etc.

---

---

## UTILITY screen

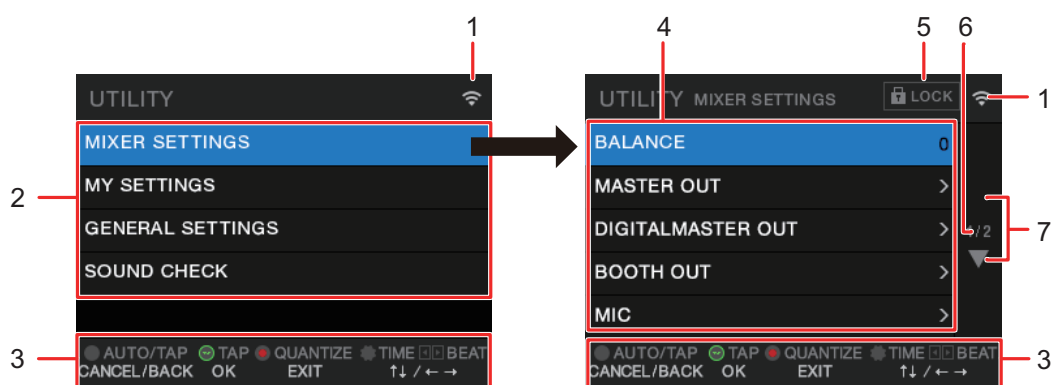

- Displays the status of the wireless LAN (Wi-Fi).
  - : Wi-Fi is turned off.
  - : Wi-Fi is turned on but not connected.
  - : Wi-Fi is turned on and connected (indication of signal strength).
- UTILITY menu** (page 76)
- Operation buttons display for the screen**
- Setting items** (page 76)
- Indicates that the setting items under [**MIXER SETTINGS**] are locked. The lock setting can be changed in [**LOCK**] under [**MIXER SETTINGS**].
- Page number**  
Indicates current page number/total number of pages.
- Turn the [**TIME**] knob in the Beat FX section or press the [**BEAT ◀**] or [**BEAT ▶**] button to display the next or previous page.

---

## Changing the settings

The following is the basic procedure for changing the Utility settings. Refer also to the instructions in other sections.

### 1 Press and hold the [QUANTIZE/UTILITY (WAKE UP)] button.

The Utility menu appears.

### 2 Turn the [TIME] knob in the Beat FX section or press the [BEAT ◀] or [BEAT ▶] button to select a setting menu, and press the [TAP] button.

The setting items for the selected Utility menu appear.

### 3 Turn the [TIME] knob or press the [BEAT ◀] or [BEAT ▶] button to select a setting item, and press the [TAP] button.

- If you press the [TAP] button when  is displayed in the selected setting item, the next level down is displayed.
- Press the [AUTO/TAP] button to cancel the setting.

 Read more: Utility settings (page 76)

### 4 Change the setting.

### 5 Press the [QUANTIZE/UTILITY (WAKE UP)] button.

The [UTILITY] screen closes.

## Utility settings

### ❖ MIXER SETTINGS

\*: Factory setting

Setting items	Description
<b>BALANCE</b> <sup>1</sup>	<p>Sets the output balance.</p> <ul style="list-style-type: none"> <li>Setting values: <b>L128</b> to <b>0*</b> to <b>R127</b></li> <li>You can adjust the balance using the X-PAD.</li> </ul>
<b>MASTER OUT</b> <sup>1</sup>	
<b>PEAK LIMITER</b>	<p>Sets whether to adjust the analog master output that exceeds the set value with peak limiter.</p> <ul style="list-style-type: none"> <li>Setting values: <b>OFF</b>, <b>21dB*</b>, <b>18dB</b>, <b>15dB</b>, <b>12dB</b></li> </ul>
<b>ATT.</b>	<p>Sets the attenuation level for the sound output from the <b>[MASTER 1]</b> and <b>[MASTER 2]</b> terminals.</p> <ul style="list-style-type: none"> <li>Setting values: <b>-12dB</b>, <b>-9dB</b>, <b>-6dB</b>, <b>-3dB</b>, <b>0dB*</b></li> </ul>
<b>MONO/STEREO</b>	<p>Sets the output method (mono/stereo) for the sound output from the <b>[MASTER 1]</b> and <b>[MASTER 2]</b> terminals.</p> <ul style="list-style-type: none"> <li>Setting values: <b>MONO</b>, <b>STEREO*</b></li> </ul>
<b>DIGITAL MASTER OUT</b> <sup>1</sup>	
<b>REFERENCE LEVEL</b>	<p>Sets the output level for when the master level indicator lights up at [0] dB.</p> <ul style="list-style-type: none"> <li>Setting values: <b>-30dBFS</b>, <b>-27dBFS</b>, <b>-24dBFS</b>, <b>-21dBFS*</b>, <b>-18dBFS</b>, <b>-15dBFS</b>, <b>-12dBFS</b>, <b>-9dBFS</b>, <b>-6dBFS</b></li> <li>Sound may be distorted even when the master level indicator doesn't show the maximum level.</li> </ul>
<b>SAMPLING RATE</b>	<p>Sets the sampling rate for the digital signal.</p> <ul style="list-style-type: none"> <li>Setting values: <b>44.1kHz</b>, <b>48kHz</b>, <b>88.2kHz</b>, <b>96kHz*</b></li> </ul>

Setting items	Description
<b>PEAK LIMITER</b>	<p>Reduces distortion to the sound output from the [<b>DIGITAL MASTER OUT</b>] terminal.</p> <ul style="list-style-type: none"> <li>Setting values: <b>OFF, ON</b>*</li> </ul>
<b>MONO/STEREO</b>	<p>Sets the output method (mono/stereo) for the sound output from the [<b>DIGITAL MASTER OUT</b>] terminal.</p> <ul style="list-style-type: none"> <li>Setting values: <b>MONO, STEREO</b>*</li> </ul>
<b>BOOTH OUT</b> <sup>1</sup>	
<b>ATT.</b>	<p>Reduces attenuation level to the sound output from the [<b>BOOTH</b>] terminals.</p> <ul style="list-style-type: none"> <li>Setting values: <b>-12dB, -9dB, -6dB, -3dB, 0dB</b>*</li> </ul>
<b>MONO/STEREO</b>	<p>Sets the output method (mono/stereo) for the sound output from the [<b>BOOTH</b>] terminals.</p> <ul style="list-style-type: none"> <li>Setting values: <b>MONO, STEREO</b>*</li> </ul>
<b>MUTE WHEN MIC ON</b>	<p>Sets whether to mute the sound output from the [<b>BOOTH</b>] terminals when the microphone is turned on.</p> <ul style="list-style-type: none"> <li>Setting values: <b>OFF</b>*, <b>ON</b></li> </ul>
<b>MIC</b>	
<b>MIC TO MASTER PEAK LIMITER</b> <sup>1</sup>	<p>Sets the limiter for the microphone sound that is input to the master sound.</p> <ul style="list-style-type: none"> <li>Setting values: <b>0dB, 3dB, 6dB, 9dB, 12dB, 15dB, 18dB, 21dB, OFF</b>*</li> </ul>
<b>MIC TO BOOTH ATT.</b> <sup>1</sup>	<p>Sets the volume for the microphone sound that is input to the sound output from the [<b>BOOTH</b>] terminals.</p> <ul style="list-style-type: none"> <li>Setting values: <b>-∞, -18dB, -15dB, -12dB, -9dB, -6dB, -3dB, 0dB</b>*</li> </ul>

Setting items	Description
<b>MIC TO BOOTH PEAK LIMITER</b>	<p>Sets the limiter for the microphone sound that is input to the sound output from the <b>[BOOTH]</b> terminals.</p> <ul style="list-style-type: none"> <li>Setting values: <b>0dB, 3dB, 6dB, 9dB, 12dB, 15dB, 18dB, 21dB, OFF*</b></li> </ul>
<b>MIC TO REC OUT EXCLUDE MIC</b>	<p>Sets whether not to input the microphone sound to the sound output from the <b>[REC OUT]</b> terminals.</p> <ul style="list-style-type: none"> <li>Setting values: <b>OFF*</b>, <b>ON</b></li> <li>Set to <b>[OFF]</b> to input the sound, and to <b>[ON]</b> not to input the sound.</li> </ul>
<b>MIC PHANTOM LOCK</b>	<p>Locks or unlocks the operation of the <b>[MIC 1 PHANTOM ON/OFF]</b> button.</p> <ul style="list-style-type: none"> <li>Setting values: <b>LOCKED*</b>, <b>UNLOCKED</b></li> </ul>
<b>AUTO STANDBY</b> <sup>1</sup>	<p>Sets the auto standby function (page 84).</p> <ul style="list-style-type: none"> <li>Setting values: <b>OFF, ON*</b></li> </ul>
<b>LOCK</b>	<p>Determines whether or not the <b>[MIXER SETTINGS]</b> can be changed.</p> <ul style="list-style-type: none"> <li>Setting values: <b>LOCKED, UNLOCKED*</b></li> </ul>
<b>OWNER SETTING</b>	
<b>SAVE</b>	<p>Saves the <b>[MIXER SETTINGS]</b> and <b>[MY SETTINGS]</b> as <b>[OWNER SETTING]</b> on the unit.</p> <p>The <b>[MY SETTINGS]</b> saved as <b>[OWNER SETTING]</b> are the default settings when you turn the unit on.</p>
<b>LOAD</b>	<p>Calls up the <b>[OWNER SETTING]</b> (the <b>[MIXER SETTINGS]</b> and <b>[MY SETTINGS]</b>) saved on the unit.</p>

<sup>1</sup> The setting is saved on the unit when you execute **[SAVE]** in **[OWNER SETTING]**.

## ❖ MY SETTINGS

\*: Factory setting

Setting items	Description
<b>MY SETTINGS LOAD</b>	Calls up the [MY SETTINGS] saved on a storage device (page 86).
<b>MY SETTINGS SAVE</b>	Saves the current [MY SETTINGS] to a storage device (page 85).
<b>LOAD STORED BEAT FX SETTING</b>	Restores the beat and [FX FREQUENCY (LOW, MID, HI)] settings for BEAT FX to the default settings of [MY SETTINGS].
<b>STORE BEAT FX SETTING</b>	Saves the current beat and [FX FREQUENCY (LOW, MID, HI)] settings as the default settings of [MY SETTINGS].
<b>HEADPHONES A</b> <sup>1</sup>	
	Sets the output method (MONO SPLIT or stereo) for the headphones monitor sound of [HEADPHONES A].
<b>MONO SPLIT</b>	<ul style="list-style-type: none"> <li>Setting values: <b>STEREO*</b>, <b>MONO SPLIT</b>, <b>NONE</b></li> <li>When set to [NONE], the headphones settings doesn't change when MY SETTINGS are imported.</li> </ul>
<b>HEADPHONES B</b> <sup>1</sup>	
	Sets the output method (MONO SPLIT or stereo) for the headphones monitor sound of [HEADPHONES B].
<b>MONO SPLIT</b>	<ul style="list-style-type: none"> <li>Setting values: <b>STEREO</b>, <b>MONO SPLIT</b>, <b>NONE*</b></li> <li>When set to [NONE], the headphones settings doesn't change when MY SETTINGS are imported.</li> </ul>
<b>BEAT FX QUANTIZE</b> <sup>1</sup>	
	Sets Quantize for BEAT FX.
<b>BEAT FX QUANTIZE</b>	<ul style="list-style-type: none"> <li>Setting values: <b>OFF</b>, <b>ON*</b></li> </ul>

Setting items	Description
<b>MIC LOW CUT</b> <sup>1</sup>	
<b>MIC LOW CUT</b>	<p>Sets the low-frequency cut function for the microphone sound.</p> <ul style="list-style-type: none"> <li>Setting values: <b>OFF, ON (for MC)*</b></li> </ul>
<b>MIC ECHO BEATS</b> <sup>1</sup>	<p>Sets the number of beats for the microphone echo.</p> <ul style="list-style-type: none"> <li>Setting values: <b>1/8, 1/4, 1/2, 3/4, 1*, 2, 4, 8</b></li> </ul>
<b>TALKOVER</b> <sup>1</sup>	
<b>MODE</b>	<p>Sets TALKOVER mode.</p> <ul style="list-style-type: none"> <li>Setting values: <b>ADVANCED*, NORMAL</b></li> <li>The [<b>ADVANCED</b>] setting outputs sound by attenuating only the mid-frequency range of the sound from channels other than the [<b>MIC</b>] channels according to the setting of the [<b>LEVEL</b>] knob.</li> <li>The [<b>NORMAL</b>] setting outputs sound by attenuating the sound from channels other than the [<b>MIC</b>] channels according to the [<b>LEVEL</b>] knob setting.</li> </ul>
<b>LEVEL</b>	<p>Sets the sound attenuation level for TALKOVER.</p> <ul style="list-style-type: none"> <li>Setting values: <b>-∞, -24dB, -18dB*, -12dB, -6dB</b></li> </ul>
<b>MIDI</b> <sup>1</sup>	
<b>CH</b>	<p>Sets the MIDI channel.</p> <ul style="list-style-type: none"> <li>Setting values: <b>1* to 16</b></li> </ul>
<b>BUTTON TYPE</b>	<p>Sets the MIDI signal transmission method.</p> <ul style="list-style-type: none"> <li>Setting values: <b>TOGGLE*, TRIGGER</b></li> </ul>



Setting items	Description
<b>BRIGHTNESS</b> <sup>1</sup>	
<b>DISPLAY</b>	<p>Sets the brightness of the touch display.</p> <ul style="list-style-type: none"> <li>Setting values: <b>1 to 5*</b>, <b>WHITE</b></li> </ul>
<b>INDICATOR</b>	<p>Sets the brightness of LED.</p> <ul style="list-style-type: none"> <li>Setting values: <b>1 to 3*</b></li> </ul>
<b>DELAY</b> <sup>2</sup> , <b>ECHO</b> <sup>2</sup> , <b>PING PONG</b> <sup>2</sup> , <b>SPIRAL</b> <sup>2</sup>	
<b>BEAT</b>	<ul style="list-style-type: none"> <li>Setting values: <b>1/16, 1/8, 1/4, 1/3, 1/2, 2/3, 3/4, 1*, 2, 4, 8, 16</b></li> </ul>
<b>FX FREQUENCY HI, MID, LOW</b>	<ul style="list-style-type: none"> <li>Setting values: <b>OFF, ON*</b></li> </ul>
<b>HELIX</b> <sup>2</sup> , <b>TRANS</b> <sup>2</sup> , <b>ROLL</b> <sup>2</sup>	
<b>BEAT</b>	<ul style="list-style-type: none"> <li>Setting values: <b>1/16, 1/8, 1/4, 1/2, 1*, 2, 4, 8, 16</b></li> </ul>
<b>FX FREQUENCY HI, MID, LOW</b>	<ul style="list-style-type: none"> <li>Setting values: <b>OFF, ON*</b></li> </ul>
<b>REVERB</b> <sup>2</sup>	
<b>BEAT</b>	<ul style="list-style-type: none"> <li>Setting values: <b>1, 10, 20, 30, 40, 50*, 60, 70, 80, 90, 100</b></li> </ul>
<b>FX FREQUENCY HI, MID, LOW</b>	<ul style="list-style-type: none"> <li>Setting values: <b>OFF, ON*</b></li> </ul>
<b>FLANGER</b> <sup>2</sup> , <b>PHASER</b> <sup>2</sup> , <b>FILTER</b> <sup>2</sup>	
<b>BEAT</b>	<ul style="list-style-type: none"> <li>Setting values: <b>1/16, 1/8, 1/4, 1/2, 1, 2, 4*, 8, 16, 32, 64</b></li> </ul>
<b>FX FREQUENCY HI, MID, LOW</b>	<ul style="list-style-type: none"> <li>Setting values: <b>OFF, ON*</b></li> </ul>

Setting items	Description
<b>TRIPLET FILTER</b> <sup>2</sup>	
<b>BEAT</b>	• Setting values: <b>1/12, 1/6, 1/3, 2/3, 4/3*</b> , 8/3, 12/3
<b>FX FREQUENCY HI, MID, LOW</b>	• Setting values: <b>OFF, ON*</b>
<b>TRIPLET ROLL</b> <sup>2</sup>	
<b>BEAT</b>	• Setting values: <b>1/12, 1/6, 1/3*</b> , 2/3, 4/3, 8/3, 12/3
<b>FX FREQUENCY HI, MID, LOW</b>	• Setting values: <b>OFF, ON*</b>
<b>MOBIUS</b> <sup>2</sup>	
<b>BEAT</b>	• Setting values: <b>1/16, 1/8, 1/4, 1/2, 1, 2, 4*</b> , 8, 16, 32, 64, -64, -32, -16, -8, -4, -2, -1, -1/2, -1/4, -1/8, -1/16
<b>FX FREQUENCY HI, MID, LOW</b>	• Setting values: <b>OFF, ON*</b>

<sup>1</sup> The setting is saved on the unit when you execute [**SAVE**] in [**OWNER SETTING**].

<sup>2</sup> Set the BEAT FX settings to be called up when you execute [**LOAD STORED BEAT FX SETTING**]. For details on the functions, see Beat FX types and settings (page 52).

## ❖ GENERAL SETTINGS menu

\*: Factory setting

Setting items	Description
<b>Wi-Fi</b>	
<b>Wi-Fi ON/OFF</b>	<p>Sets whether to use wireless LAN (Wi-Fi) (page 64).</p> <ul style="list-style-type: none"> <li>Setting values: <b>OFF*</b>, <b>ON</b></li> </ul>
<b>CONNECT BY WPS</b>	<p>Connects the unit with a wireless router (access point) using the WPS button on the router (page 65).</p>
<b>CONNECT BY PASSWORD</b>	<p>Connects the unit with a wireless router (access point) using an access point of the router (pages 68, 70).</p> <ul style="list-style-type: none"> <li>Setting values: <b>SELECT SSID</b>, <b>MANUAL</b></li> <li>If selecting [<b>SELECT SSID</b>], connect the unit with a wireless router by selecting an access point found by the search function (page 68).</li> <li>If selecting [<b>MANUAL</b>], connect the unit with a wireless router by specifying an access point of the wireless router (page 70).</li> </ul>
<b>INFORMATION</b>	<p>Displays SSID, IP address, and MAC address for the wireless LAN (Wi-Fi) connection (page 72).</p>
<b>LAN</b>	
<b>INFORMATION</b>	<p>Displays IP address and MAC address for the wired LAN connection (page 73).</p>

## ❖ SOUND CHECK menu

➡ Read more: Sound check (page 87)

\*: Factory setting

Setting items	Description
<b>SOURCE</b>	<p>Sets a signal type (white noise/sine wave) to generate.</p> <ul style="list-style-type: none"> <li>Setting values: <b>NOISE*</b>, <b>SINE</b></li> <li>The [<b>NOISE</b>] setting generates white noise.</li> <li>The [<b>SINE</b>] setting generates a sine wave.</li> <li>When set to [<b>SINE</b>], you can use the X-PAD to set a predetermined frequency.</li> </ul>
<b>STEREO</b>	<p>Sets a channel (left or right) to generate a signal.</p> <ul style="list-style-type: none"> <li>Setting values: <b>L</b>, <b>L+R*</b>, <b>R</b></li> <li>The [<b>L</b>] setting generates signals in the left channel.</li> <li>The [<b>L+R</b>] setting generates signals in the left and right channels.</li> <li>The [<b>R</b>] setting generates signals in the right channel.</li> </ul>
<b>VOLUME</b>	Adjusts the volume of sound check signals.
<b>OUTPUT</b>	Selects where the signals are output to.

## Auto standby

When [**AUTO STANDBY**] is set to [**ON**], the unit enters standby mode after 10 hours without being used in the following ways.

- No audio signals are input to the channels on the unit.
- There is no PRO DJ LINK connection.

Press the [**QUANTIZE/UTILITY (WAKE UP)**] button to exit standby mode.

- The factory setting is [**ON**].
- Set [**AUTO STANDBY**] to [**OFF**] if you don't need to use the auto standby function.

---

## Saving MY SETTINGS to a storage device

You can save MY SETTINGS on a storage device plugged into the unit, or you can save them to rekordbox in PRO DJ LINK.

### 1 Connect a storage device.

➡ Read more: Connecting to the terminals on the top and front panels (page 22)

### 2 Press and hold the [QUANTIZE/UTILITY (WAKE UP)] button.

The Utility menu appears.

### 3 Turn the [TIME] knob in the Beat FX section or press the [BEAT ◀] or [BEAT ▶] button to select [MY SETTINGS], and press the [TAP] button.

The setting items under [MY SETTINGS] appear.

### 4 Turn the [TIME] knob or press the [BEAT ◀] or [BEAT ▶] button to select [MY SETTINGS SAVE], and press the [TAP] button.

Storage devices are listed on the [SAVE] screen.

### 5 Turn the [TIME] knob or press the [BEAT ◀] or [BEAT ▶] button to select a storage device to save settings to, and press the [TAP] button.

MY SETTINGS are saved to the storage device.

- To cancel the setting, press the [AUTO/TAP] button.

### 6 Press the [QUANTIZE/UTILITY (WAKE UP)] button.

The [UTILITY] screen closes.

---

## Calling up MY SETTINGS saved on a storage device

You can call up MY SETTINGS on a storage device plugged into a multi player that is connected to the unit via PRO DJ LINK, or you can call them up from rekordbox.

### 1 Connect a storage device.

➡ Read more: Connecting to the terminals on the top and front panels (page 22)

### 2 Press and hold the [QUANTITY/UTILITY (WAKE UP)] button.

The Utility menu appears.

### 3 Turn the [TIME] knob in the Beat FX section or press the [BEAT ◀] or [BEAT ▶] button to select [MY SETTINGS], and press the [TAP] button.

The setting items under [MY SETTINGS] appear.

### 4 Turn the [TIME] knob or press the [BEAT ◀] or [BEAT ▶] button to select [MY SETTINGS LOAD], and press the [TAP] button.

Storage devices are listed on the [LOAD] screen.

### 5 Turn the [TIME] knob or press the [BEAT ◀] or [BEAT ▶] button to select a storage device to call up settings from, and press the [TAP] button.

MY SETTINGS are called up.

- To cancel the setting, press the [AUTO/TAP] button.

### 6 Press the [QUANTIZE/UTILITY (WAKE UP)] button.

The [UTILITY] screen closes.

## Sound check

You can perform sound checks for connected devices (e.g. speakers) by generating signals from the unit.

### 1 Press and hold the [QUANTITY/UTILITY (WAKE UP)] button.

The Utility menu appears.

### 2 Turn the [TIME] knob in the Beat FX section or press the [BEAT ◀] or [BEAT ▶] button to select [SOUND CHECK], and press the [TAP] button.

The [SOUND CHECK] screen appears.

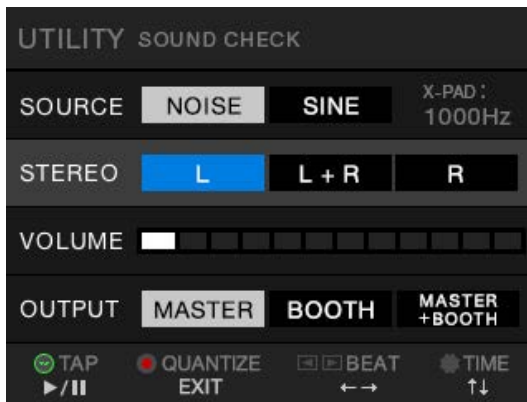

### 3 Turn the [TIME] knob to select a setting item.

### 4 Press the [BEAT ◀] or [BEAT ▶] button to select a setting.

➡ Read more: SOUND CHECK menu (page 84)

### 5 Press the [TAP] button.

Sound is output.

- To stop outputting the sound, press the [TAP] button again.

### 6 Press the [QUANTIZE/UTILITY (WAKE UP)] button.

The [UTILITY] screen closes.

---

## Restoring the factory settings

- 1 While pressing the [QUANTIZE/UTILITY (WAKE UP)] button, press the [⏻] button.

The [FACTORY RESET] screen appears.



- 2 Turn the [TIME] knob in the Beat FX section to select [YES], and press the [TAP] button.
- 3 Press the [⏻] button to turn the unit off.

The factory settings are restored.



---

---

# Specifications

## General

Power requirements .....	AC 110 V – 240 V, 50 Hz / 60 Hz
Power consumption .....	61 W
Main unit weight .....	10.2 kg / 22.5 lbs.
Max. external dimensions ..... (W × D × H)	407.4 × 458.3 × 107.9 mm / 16.4" x 18.4" x 4.25"
Max. external dimensions (when the wireless antenna stands upright) ..... (W × D × H)	407.4 × 458.3 × 140.7 mm / 16.4" × 18.4" × 5.54"
Tolerable operating temperature .....	+5 °C – +35 °C (+41 °F – +95 °F)
Tolerable operating humidity .....	5 % – 85 % (no condensation)

## Audio section

Sampling rate .....	96 kHz
MASTER, BOOTH, REC, SEND D/A converter .....	32bit
CH input A/D converter .....	32bit
Other A/D and D/A converters .....	24bit
Frequency characteristic	
LINE .....	20 Hz – 40 kHz
S/N ratio (rated output, A-WEIGHTED)	
USB, DIGITAL IN .....	114 dB
PHONO .....	88 dB
LINE .....	105 dB
MIC 1, MIC 2 .....	79 dB
Total harmonic distortion (LINE – MASTER 1, 20 Hz – 40 kHz BW) .....	0.005 %
Standard input level / Input impedance	
PHONO .....	-52 dBu / 47 kΩ
LINE .....	-12 dBu / 47 kΩ
MIC 1, MIC 2 .....	-57 dBu / 3.5 kΩ
RETURN .....	-12 dBu / 47 kΩ
Max. input level	
PHONO .....	-17.8 dBu
LINE .....	+15 dBu
MIC 1, MIC 2 .....	+2 dBu
RETURN .....	+12 dBu
Standard output level / Load impedance / Output impedance	
MASTER 1 .....	+6 dBu / 10 kΩ / 360 Ω

# Specifications

MASTER 2 .....	+2 dBu / 10 k $\Omega$ / 700 $\Omega$
REC OUT .....	-8 dBu / 10 k $\Omega$ / 700 $\Omega$
BOOTH .....	+6 dBu / 10 k $\Omega$ / 360 $\Omega$
SEND .....	-6 dBu / 10 k $\Omega$ / 700 $\Omega$
PHONES .....	+8 dBu / 32 $\Omega$ / 1 $\Omega$ or lower
Rated output level / Load impedance	
MASTER 1 .....	+25 dBu / 10 k $\Omega$
MASTER 2 .....	+21 dBu / 10 k $\Omega$
BOOTH .....	+25 dBu / 10 k $\Omega$
Crosstalk	
LINE .....	82 dB
Channel equalizer characteristic	
HI.....	-26 dB – +6 dB (20 kHz)
MID.....	-26 dB – +6 dB (1 kHz)
LOW .....	-26 dB – +6 dB (20 Hz)
Microphone equalizer characteristic	
HI.....	-12 dB – +12 dB (10 kHz)
LOW .....	-12 dB – +12 dB (100 Hz)
BOOTH MONITOR equalizer feature	
HI.....	-12 dB – +6 dB (10 kHz)
LOW .....	-12 dB – +6 dB (100 Hz)

## Input / Output terminals

### PHONO input terminal

RCA pin jacks ..... 4 sets

### LINE input terminal

RCA pin jacks ..... 4 sets

### MIC1 input terminal (XLR / TRS)

XLR connector & 1/4" TRS jack ..... 1 set

Power supply ..... 48 V / 10 mA or less

### MIC2 input terminal (TRS)

1/4" TRS jack ..... 1 set

### RETURN input terminals (TS)

1/4" TS jack ..... 1 set

### DIGITAL IN coaxial input terminal

RCA pin jacks ..... 4 sets

### MASTER output terminal

XLR connector ..... 1 set

RCA pin jacks ..... 1 set

# Specifications

BOOTH output terminal (TRS)	
1/4" TRS jack .....	1 set
REC OUT output terminal	
RCA pin jacks .....	1 set
SEND output terminal (TS)	
1/4" TS jack .....	1 set
DIGITAL MASTER OUT coaxial output terminal	
RCA pin jacks .....	1 set
PHONES output terminal	
1/4" stereo jack .....	2 sets
3.5 mm stereo mini-jack .....	2 sets
USB terminal	
USB Type-A .....	1 set
Power supply .....	5 V / 2.1 A or less
USB Type-B / USB Type-C .....	2 sets
LINK terminal	
LAN terminal (100BASE-TX) .....	1 set

## Wireless LAN section

Supported standards .....	IEEE 802.11 a/b/g/n/ac
Frequency band used .....	2.4 GHz / 5 GHz

## Bluetooth section

Wireless system .....	Bluetooth Ver.5.0
Maximum transmission distance .....	Approximately 10 m* in unobstructed circumstances
Frequency band used .....	2.4 GHz
Modulation method .....	FH-SS (Frequency Hopping Spread Spectrum)
Compatible Codecs .....	SBC, AAC

\* Transmission distances are a guideline. Transmission distance may change depending on the surrounding environment.

The specifications and design of this product are subject to change without notice.

## Block diagram

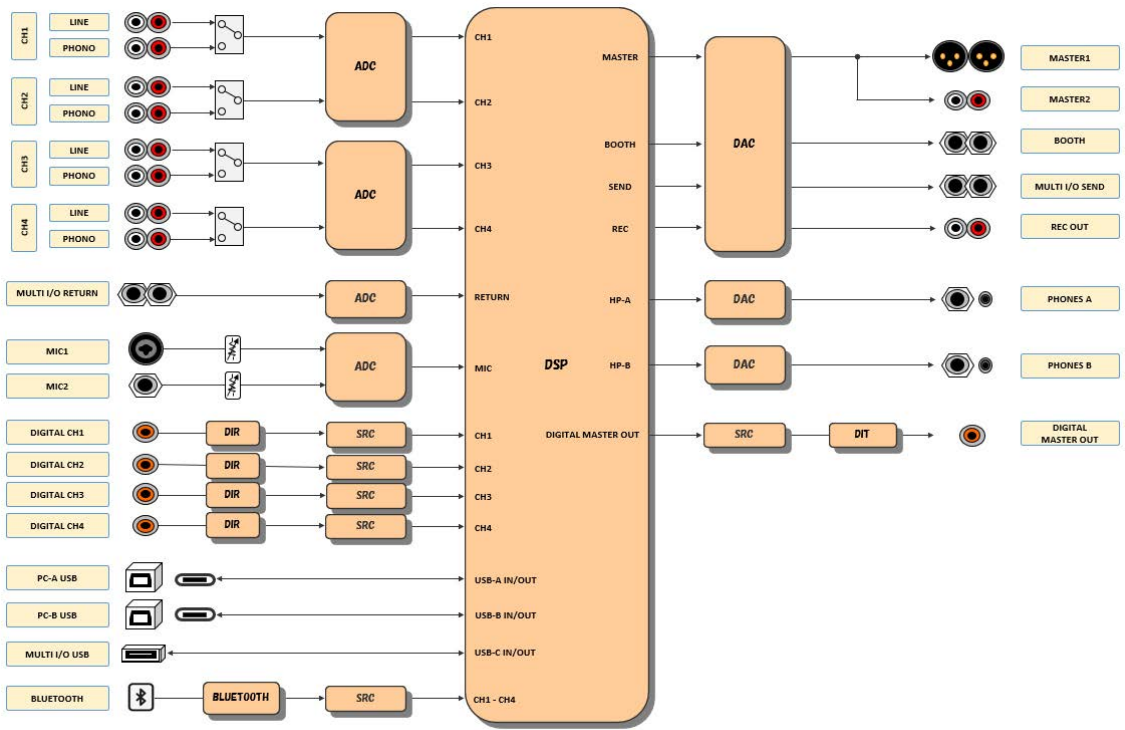

# Specifications

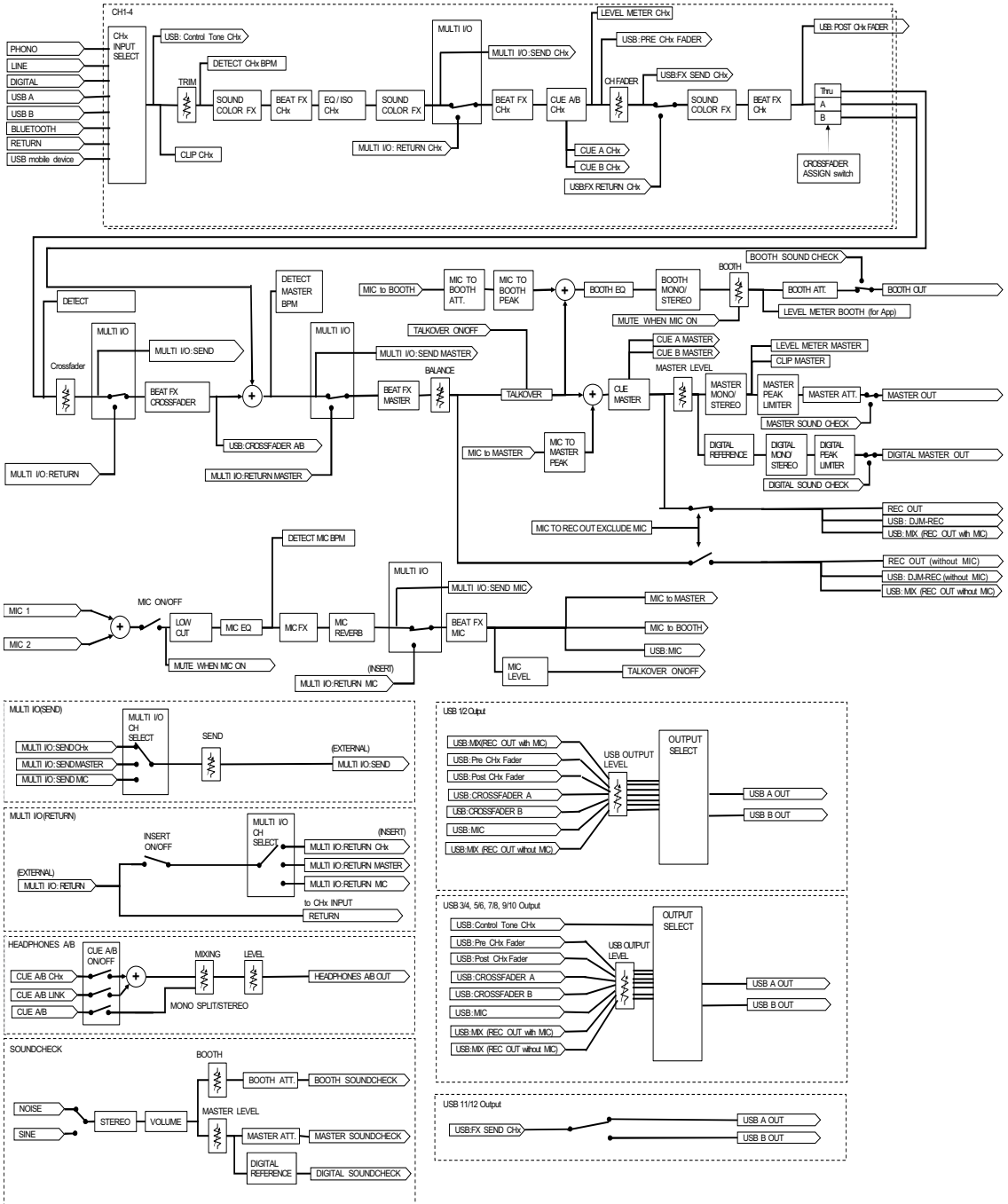

---

---

# Additional information

---

---

## Troubleshooting

If you think something is wrong with the unit, check the information below and refer to the [FAQ] for the DJM-A9 at the URL below.

[pioneerdj.com/support/](http://pioneerdj.com/support/)

- Inspect devices connected with the unit.
- The unit may restore proper operation after you turn it off and on.

If the problems continue, read the “Precautions for Use” and consult an authorized service company or your dealer.

---

---

## Power

### ❖ The unit doesn't turn on.

- Check if the power cord is connected properly.
- Press the ⏻ button on the rear of the unit to turn it on.

---

---

## Audio output

### ❖ The unit doesn't output sound. The volume is low.

- Check if the input selector switch is set properly.
- Check all cables are connected properly.
- Wipe any dust or dirt off the terminals and plugs before connecting them.
- Change the [ATT.] setting for [MASTER OUT] in the Utility settings.

### ❖ The unit doesn't output the digital sound.

- Make sure the specified [SAMPLING RATE] setting for [DIGITAL MASTER OUT] in the Utility settings is supported by the connected devices.

## ❖ Sound is distorted.

### For the master sound:

- Adjust the [LEVEL] knob in the MASTER section so the master level indicator lights up with the peak level at around [0] dB.
- Set [ATT.] for [MASTER OUT] to a setting between [-3dB] and [-12dB] in the Utility settings.

### For the channel input sound:

- Adjust the [TRIM] knob so the channel level indicator lights up with the peak level at around [0] dB.

## ❖ The crossfader doesn't work.

- Check if the [CROSSFADER ASSIGN (A, THRU, B)] selector switch is set properly.

---

## Effects

## ❖ BEAT FX doesn't work.

- Make sure the [FX FREQUENCY (HI, MID, LOW)] button is lit for the band you want to add the effect to.

## ❖ Sound Color FX doesn't work.

- Check if the [COLOR] knob is set properly.
- Check if the [PARAMETER] knob is set properly.

## ❖ Mic FX doesn't work.

- Check if the [MIC FX PARAMETER] knob is set properly.

## ❖ An external effects unit or a mobile device connected to MULTI I/O doesn't work.

- Select a channel to add the effect to with the [CH SELECT] button.
- Make sure any external effects unit is connected to the [SEND] and [RETURN] terminals properly.
- Make sure the mobile device is properly connected to the mobile device connection terminal (USB port). Launch the FX application on the mobile device.
- Make sure the [INSERT SOURCE] selector switch is set properly.
- Check if the [INSERT] button is turned on.

### ❖ **Sound from an external effects unit is distorted.**

- Make sure the volume for the external effects unit is set properly.

### ❖ **The tempo (BPM) of a track can't be measured.**

#### **The measured tempo is wrong.**

- Adjust the [TRIM] knob so the channel level indicator lights up with the peak level at around [0] dB.
- Tempo (BPM) can't be measured for some tracks. Use the [TAP] button to manually set the tempo for those tracks.

### ❖ **The measured tempo (BPM) differs from the value shown on the information of the track.**

- The values don't match when BPM measuring methods are different.

---

## MIDI

### ❖ **You can't control a MIDI device with the unit.**

- Press the [MIDI ON/OFF] button to turn MIDI on.
- Assign this unit's MIDI messages to the software. For details on assignment, refer to the instruction manual for the software.

---

## Connections

### ❖ **The unit isn't recognized by the connected PC/Mac.**

#### **The USB connection indicator is blinking slowly.**

- Install the dedicated software on the PC/Mac. If the software is already installed, reinstall it.

### ❖ **Sound from the connected PC/Mac isn't outputting from the unit.**

- Make sure the PC/Mac is connected properly.
- It's recommended to connect this unit and a PC/Mac directly with a USB cable.
- When using a USB hub, use a product recommended by the manufacturer of your PC/Mac.
- We don't guarantee the operation of all USB hubs.



- Select this unit in the audio output device settings in the software. For details, refer to the instruction manual for the software.
- Set the input selector switch to [A] or [B].

### ❖ **Sound is distorted when a turntable is connected to the [PHONO] terminals on the unit.**

**The status of the channel level indicator doesn't change when you turn the [TRIM] knob.**

- Check if the connected turntable has a built-in phono equalizer (if it does, connect the turntable to the [LINE] terminals).
- If the turntable has a PHONO/LINE selector switch, set it to PHONO.
- If the audio interface for PC/Mac, which is connected between the unit and the turntable, is a line-level device, connect the turntable to the [LINE] terminals.

---

## Bluetooth

### ❖ **The unit can't connect with a Bluetooth device.**

- Turn on the unit and the Bluetooth device again, and perform the pairing procedure.

### ❖ **Sound is interrupted.**

- If the unit and the Bluetooth device is placed far apart, bring them closer together.
- If there is an obstacle between this unit and the Bluetooth device, remove it.

---

## Wireless LAN (Wi-Fi)

### ❖ **The unit can't connect to a Wireless LAN using WPS.**

- Check if the wireless router (access point) supports WPS. If it doesn't, try other connection methods.

### ❖ **The unit can't connect to an access point.**

- Check if the network (SSID), password, and encryption method are set correctly. Match the settings on this unit with the network settings.

### ❖ The access point can't be found.

- If the unit and the wireless router (access point) are placed far apart, bring them closer together.
- If there is an obstacle between this unit and the wireless router (access point), remove it.

---

---

## LCD display

- Small black or shining points may appear on the LCD display. This is a phenomenon inherent to LCD displays and not a malfunction.
- When using the unit in cold places, the LCD display may be dark for a while after the power is turned on. Normal brightness will restore after a while.
- When the LCD display is exposed to direct sunlight, the light will reflect off it, making it difficult to see. Block the direct sunlight to improve visibility of the display.

---

## Cleaning

Wipe with a dry soft cloth.

- Do not use organic solvents, acids or alkalis for cleaning.

---

## Trademarks and registered trademarks

- rekordbox™ is a trademark or registered trademark of AlphaTheta Corporation.
- PRO DJ LINK™ is a trademark or registered trademark of AlphaTheta Corporation.
- Mac, macOS and Finder are registered trademarks of Apple Inc. in the U.S. and other countries.
- Windows is a registered trademark of Microsoft Corporation in the U.S. and other countries.
- ASIO is a trademark or registered trademark of Steinberg Media Technologies GmbH.
- The Bluetooth® word mark and logos are registered trademarks owned by the Bluetooth SIG, Inc. and any use of such marks by AlphaTheta Corporation is under license. Other trademarks and trade names are those of their respective owners.
- Wi-Fi is a registered trademark of the Wi-Fi Alliance.

Other product, technology and company names, etc. mentioned herein are trademarks or registered trademarks of their respective owners.

### **About using MP3 files**

This product has been licensed for nonprofit use. This product has not been licensed for commercial purposes (for profit-making use), such as broadcasting (terrestrial, satellite, cable or other types of broadcasting), streaming on the Internet, Intranet (a corporate network) or other types of networks or distributing of electronic information (online digital music distribution service). You need to acquire the corresponding licenses for such uses. For details, see <http://www.mp3licensing.com>.

---

## Software license notice

The licenses for the open source software used on this product are shown below. For accuracy purposes, here we have included the original texts (in English).

Copyright © 2010 Texas Instruments Incorporated - <http://www.ti.com/>

Redistribution and use in source and binary forms, with or without modification, are permitted provided that the following conditions are met:

Redistributions of source code must retain the above copyright notice, this list of conditions and the following disclaimer.

Redistributions in binary form must reproduce the above copyright notice, this list of conditions and the following disclaimer in the documentation and/or other materials provided with the distribution.

Neither the name of Texas Instruments Incorporated nor the names of its contributors may be used to endorse or promote products derived from this software without specific prior written permission.

THIS SOFTWARE IS PROVIDED BY THE COPYRIGHT HOLDERS AND CONTRIBUTORS «AS IS» AND ANY EXPRESS OR IMPLIED WARRANTIES, INCLUDING, BUT NOT LIMITED TO, THE IMPLIED WARRANTIES OF MERCHANTABILITY AND FITNESS FOR A PARTICULAR PURPOSE ARE DISCLAIMED. IN NO EVENT SHALL THE COPYRIGHT OWNER OR CONTRIBUTORS BE LIABLE FOR ANY DIRECT, INDIRECT, INCIDENTAL, SPECIAL, EXEMPLARY, OR CONSEQUENTIAL DAMAGES (INCLUDING, BUT NOT LIMITED TO, PROCUREMENT OF SUBSTITUTE GOODS OR SERVICES; LOSS OF USE, DATA, OR PROFITS; OR BUSINESS INTERRUPTION) HOWEVER CAUSED AND ON ANY THEORY OF LIABILITY, WHETHER IN CONTRACT, STRICT LIABILITY, OR TORT (INCLUDING NEGLIGENCE OR OTHERWISE) ARISING IN ANY WAY OUT OF THE USE OF THIS SOFTWARE, EVEN IF ADVISED OF THE POSSIBILITY OF SUCH DAMAGE.

### – The curl license

This software includes open source software codes licensed under the Curl license.

### COPYRIGHT AND PERMISSION NOTICE

Copyright (c) 1996 - 2021, Daniel Stenberg, daniel@haxx.se, and many contributors, see the THANKS file.

All rights reserved.

Permission to use, copy, modify, and distribute this software for any purpose with or without fee is hereby granted, provided that the above copyright notice and this permission notice appear in all copies.

THE SOFTWARE IS PROVIDED "AS IS", WITHOUT WARRANTY OF ANY KIND, EXPRESS OR IMPLIED, INCLUDING BUT NOT LIMITED TO THE WARRANTIES OF MERCHANTABILITY, FITNESS FOR A PARTICULAR PURPOSE AND NONINFRINGEMENT OF THIRD PARTY RIGHTS. IN NO EVENT SHALL THE AUTHORS OR COPYRIGHT HOLDERS BE LIABLE FOR ANY CLAIM, DAMAGES OR OTHER LIABILITY, WHETHER IN AN ACTION OF CONTRACT, TORT OR OTHERWISE, ARISING FROM, OUT OF OR IN CONNECTION WITH THE SOFTWARE OR THE USE OR OTHER DEALINGS IN THE SOFTWARE.

Except as contained in this notice, the name of a copyright holder shall not be used in advertising or otherwise to promote the sale, use or other dealings in this Software without prior written authorization of the copyright holder.

### – PicoJSON - a C++ JSON parser / serializer

This software includes open source software codes licensed under BSD 2-Clause "Simplified" License.

Copyright 2009-2010 Cybozu Labs, Inc.

Copyright 2011-2014 Kazuho Oku

All rights reserved.

Redistribution and use in source and binary forms, with or without modification, are permitted provided that the following conditions are met:

1. Redistributions of source code must retain the above copyright notice, this list of conditions and the following disclaimer.
2. Redistributions in binary form must reproduce the above copyright notice, this list of conditions and the following disclaimer in the documentation and/or other materials provided with the distribution.

THIS SOFTWARE IS PROVIDED BY THE COPYRIGHT HOLDERS AND CONTRIBUTORS "AS IS" AND ANY EXPRESS OR IMPLIED WARRANTIES, INCLUDING, BUT NOT LIMITED TO, THE IMPLIED WARRANTIES OF MERCHANTABILITY AND FITNESS FOR A PARTICULAR PURPOSE ARE DISCLAIMED. IN NO EVENT SHALL THE COPYRIGHT HOLDER OR CONTRIBUTORS BE LIABLE FOR ANY DIRECT, INDIRECT, INCIDENTAL, SPECIAL, EXEMPLARY, OR CONSEQUENTIAL DAMAGES (INCLUDING, BUT NOT LIMITED TO, PROCUREMENT OF SUBSTITUTE GOODS OR SERVICES; LOSS OF USE, DATA, OR PROFITS; OR BUSINESS INTERRUPTION) HOWEVER CAUSED AND ON ANY THEORY OF LIABILITY, WHETHER IN CONTRACT, STRICT LIABILITY, OR TORT (INCLUDING NEGLIGENCE OR OTHERWISE) ARISING IN ANY WAY OUT OF THE USE OF THIS SOFTWARE, EVEN IF ADVISED OF THE POSSIBILITY OF SUCH DAMAGE.

Copyright (c) 1999-2007, The Board of Trustees of the University of Illinois  
All Rights Reserved.

Iperf performance test

Mark Gates

Ajay Tirumala

Jim Ferguson

Jon Dugan

Feng Qin

Kevin Gibbs

John Estabrook

National Laboratory for Applied Network Research

National Center for Supercomputing Applications

University of Illinois at Urbana-Champaign

<http://www.ncsa.uiuc.edu>

Permission is hereby granted, free of charge, to any person obtaining a copy of this software (Iperf) and associated documentation files (the "Software"), to deal in the Software without restriction, including without limitation the rights to use, copy, modify, merge, publish, distribute, sublicense, and/or sell copies of the Software, and to permit persons to whom the Software is furnished to do so, subject to the following conditions:

Redistributions of source code must retain the above copyright notice, this list of conditions and the following disclaimers.

Redistributions in binary form must reproduce the above copyright notice, this list of conditions and the following disclaimers in the documentation and/or other materials provided with the distribution.

Neither the names of the University of Illinois, NCSA, nor the names of its contributors may be used to endorse or promote products derived from this Software without specific prior written permission. THE SOFTWARE IS PROVIDED "AS IS", WITHOUT WARRANTY OF ANY KIND, EXPRESS OR IMPLIED, INCLUDING BUT NOT LIMITED TO THE WARRANTIES OF MERCHANTABILITY, FITNESS FOR A PARTICULAR PURPOSE AND NONINFRINGEMENT. IN NO EVENT SHALL THE CONTRIBUTORS OR COPYRIGHT HOLDERS BE LIABLE FOR ANY CLAIM, DAMAGES OR OTHER LIABILITY, WHETHER IN AN ACTION OF CONTRACT, TORT OR OTHERWISE, ARISING FROM, OUT OF OR IN CONNECTION WITH THE SOFTWARE OR THE USE OR OTHER DEALINGS IN THE SOFTWARE.

## LICENSE ISSUES

=====

The OpenSSL toolkit stays under a double license, i.e. both the conditions of the OpenSSL License and the original SSLeay license apply to the toolkit.  
See below for the actual license texts.

## OpenSSL License

-----

=====

Copyright (c) 1998-2019 The OpenSSL Project. All rights reserved.

Redistribution and use in source and binary forms, with or without modification, are permitted provided that the following conditions are met:

1. Redistributions of source code must retain the above copyright notice, this list of conditions and the following disclaimer.
2. Redistributions in binary form must reproduce the above copyright notice, this list of conditions and the following disclaimer in the documentation and/or other materials provided with the distribution.

## Additional information

3. All advertising materials mentioning features or use of this software must display the following acknowledgment:  
"This product includes software developed by the OpenSSL Project for use in the OpenSSL Toolkit. (<http://www.openssl.org/>)"
4. The names "OpenSSL Toolkit" and "OpenSSL Project" must not be used to endorse or promote products derived from this software without prior written permission. For written permission, please contact [openssl-core@openssl.org](mailto:openssl-core@openssl.org).
5. Products derived from this software may not be called "OpenSSL" nor may "OpenSSL" appear in their names without prior written permission of the OpenSSL Project.
6. Redistributions of any form whatsoever must retain the following acknowledgment:  
"This product includes software developed by the OpenSSL Project for use in the OpenSSL Toolkit (<http://www.openssl.org/>)"

THIS SOFTWARE IS PROVIDED BY THE OpenSSL PROJECT "AS IS" AND ANY EXPRESSED OR IMPLIED WARRANTIES, INCLUDING, BUT NOT LIMITED TO, THE IMPLIED WARRANTIES OF MERCHANTABILITY AND FITNESS FOR A PARTICULAR PURPOSE ARE DISCLAIMED. IN NO EVENT SHALL THE OpenSSL PROJECT OR ITS CONTRIBUTORS BE LIABLE FOR ANY DIRECT, INDIRECT, INCIDENTAL, SPECIAL, EXEMPLARY, OR CONSEQUENTIAL DAMAGES (INCLUDING, BUT NOT LIMITED TO, PROCUREMENT OF SUBSTITUTE GOODS OR SERVICES; LOSS OF USE, DATA, OR PROFITS; OR BUSINESS INTERRUPTION) HOWEVER CAUSED AND ON ANY THEORY OF LIABILITY, WHETHER IN CONTRACT, STRICT LIABILITY, OR TORT (INCLUDING NEGLIGENCE OR OTHERWISE) ARISING IN ANY WAY OUT OF THE USE OF THIS SOFTWARE, EVEN IF ADVISED OF THE POSSIBILITY OF SUCH DAMAGE.

=====

This product includes cryptographic software written by Eric Young ([eay@cryptsoft.com](mailto:eay@cryptsoft.com)).  
This product includes software written by Tim Hudson ([tjh@cryptsoft.com](mailto:tjh@cryptsoft.com)).

Original SSLeay License

-----

Copyright (C) 1995-1998 Eric Young ([eay@cryptsoft.com](mailto:eay@cryptsoft.com))  
All rights reserved.

This package is an SSL implementation written by Eric Young ([eay@cryptsoft.com](mailto:eay@cryptsoft.com)).  
The implementation was written so as to conform with Netscapes SSL.

This library is free for commercial and non-commercial use as long as the following conditions are adhered to. The following conditions apply to all code found in this distribution, be it the



RC4, RSA, lhash, DES, etc., code; not just the SSL code. The SSL documentation included with this distribution is covered by the same copyright terms except that the holder is Tim Hudson (tjh@cryptsoft.com).

Copyright remains Eric Young's, and as such any Copyright notices in the code are not to be removed.

If this package is used in a product, Eric Young should be given attribution as the author of the parts of the library used. This can be in the form of a textual message at program startup or in documentation (online or textual) provided with the package.

Redistribution and use in source and binary forms, with or without modification, are permitted provided that the following conditions are met:

1. Redistributions of source code must retain the copyright notice, this list of conditions and the following disclaimer.
2. Redistributions in binary form must reproduce the above copyright notice, this list of conditions and the following disclaimer in the documentation and/or other materials provided with the distribution.
3. All advertising materials mentioning features or use of this software must display the following acknowledgement:  
"This product includes cryptographic software written by Eric Young (eay@cryptsoft.com)"  
The word 'cryptographic' can be left out if the routines from the library being used are not cryptographic related :-).
4. If you include any Windows specific code (or a derivative thereof) from the apps directory (application code) you must include an acknowledgement:  
"This product includes software written by Tim Hudson (tjh@cryptsoft.com)"

THIS SOFTWARE IS PROVIDED BY ERIC YOUNG "AS IS" AND ANY EXPRESS OR IMPLIED WARRANTIES, INCLUDING, BUT NOT LIMITED TO, THE IMPLIED WARRANTIES OF MERCHANTABILITY AND FITNESS FOR A PARTICULAR PURPOSE ARE DISCLAIMED. IN NO EVENT SHALL THE AUTHOR OR CONTRIBUTORS BE LIABLE FOR ANY DIRECT, INDIRECT, INCIDENTAL, SPECIAL, EXEMPLARY, OR CONSEQUENTIAL DAMAGES (INCLUDING, BUT NOT LIMITED TO, PROCUREMENT OF SUBSTITUTE GOODS OR SERVICES; LOSS OF USE, DATA, OR PROFITS; OR BUSINESS INTERRUPTION) HOWEVER CAUSED AND ON ANY THEORY OF LIABILITY, WHETHER IN CONTRACT, STRICT LIABILITY, OR TORT (INCLUDING NEGLIGENCE OR OTHERWISE) ARISING IN ANY WAY OUT OF THE USE OF THIS SOFTWARE, EVEN IF ADVISED OF THE POSSIBILITY OF SUCH DAMAGE.

The licence and distribution terms for any publically available version or derivative of this code cannot be changed. i.e. this code cannot simply be copied and put under another distribution licence [including the GNU Public Licence.]

wpa\_supplicant and hostapd  
-----

Copyright (c) 2002-2019, Jouni Malinen <j@w1.fi> and contributors  
All Rights Reserved.

See the README file for the current license terms.

This software was previously distributed under BSD/GPL v2 dual license terms that allowed either of those license alternatives to be selected. As of February 11, 2012, the project has chosen to use only the BSD license option for future distribution. As such, the GPL v2 license option is no longer used. It should be noted that the BSD license option (the one with advertisement clause removed) is compatible with GPL and as such, does not prevent use of this software in projects that use GPL.

Some of the files may still include pointers to GPL version 2 license terms. However, such copyright and license notifications are maintained only for attribution purposes and any distribution of this software after February 11, 2012 is no longer under the GPL v2 option.

### **Apache**

Copyright (c) 2009-2019 ARM Limited. All rights reserved.

SPDX-License-Identifier: Apache-2.0

Licensed under the Apache License, Version 2.0 (the License); you may not use this file except in compliance with the License.

You may obtain a copy of the License at

[www.apache.org/licenses/LICENSE-2.0](http://www.apache.org/licenses/LICENSE-2.0)

Unless required by applicable law or agreed to in writing, software distributed under the License is distributed on an AS IS BASIS, WITHOUT WARRANTIES OR CONDITIONS OF ANY KIND, either express or implied.

See the License for the specific language governing permissions and limitations under the License.

## **BSD**

The BSD-3-Clause License

Copyright (c) 2015, Freescale Semiconductor, Inc.

Copyright 2016-2020 NXP

All rights reserved.

Redistribution and use in source and binary forms, with or without modification, are permitted provided that the following conditions are met:

1. Redistributions of source code must retain the above copyright notice, this list of conditions and the following disclaimer.
2. Redistributions in binary form must reproduce the above copyright notice, this list of conditions and the following disclaimer in the documentation and/or other materials provided with the distribution.
3. Neither the name of the copyright holder nor the names of its contributors may be used to endorse or promote products derived from this software without specific prior written permission.

THIS SOFTWARE IS PROVIDED BY THE COPYRIGHT HOLDERS AND CONTRIBUTORS "AS IS" AND ANY EXPRESS OR IMPLIED WARRANTIES, INCLUDING, BUT NOT LIMITED TO, THE IMPLIED WARRANTIES OF MERCHANTABILITY AND FITNESS FOR A PARTICULAR PURPOSE ARE DISCLAIMED. IN NO EVENT SHALL THE COPYRIGHT HOLDER OR CONTRIBUTORS BE LIABLE FOR ANY DIRECT, INDIRECT, INCIDENTAL, SPECIAL, EXEMPLARY, OR CONSEQUENTIAL DAMAGES (INCLUDING, BUT NOT LIMITED TO, PROCUREMENT OF SUBSTITUTE GOODS OR SERVICES; LOSS OF USE, DATA, OR PROFITS; OR BUSINESS INTERRUPTION) HOWEVER CAUSED AND ON ANY THEORY OF LIABILITY, WHETHER IN CONTRACT, STRICT LIABILITY, OR TORT (INCLUDING NEGLIGENCE OR OTHERWISE) ARISING IN ANY WAY OUT OF THE USE OF THIS SOFTWARE, EVEN IF ADVISED OF THE POSSIBILITY OF SUCH DAMAGE.

---

## Cautions on copyrights

Recordings you have made are for your personal enjoyment and according to copyright laws may not be used without the consent of the copyright holder.

- Music recorded from CDs, etc., is protected by the copyright laws of individual countries and by international treaties. It is the full responsibility of the person who has recorded the music to ensure that it is used legally.
- When handling music downloaded from the Internet, etc., it is the full responsibility of the person who has downloaded the music to ensure that it is used in accordance with the contract concluded with the download site.

The specifications and design of this product are subject to change without notice.

© 2022 AlphaTheta Corporation. All rights reserved.

<DRI1785-A>