

BL Superslim Tilt 400

Tiltable wall mount

Item no.: 8404

The BL Superslim Tilt 400 is a tiltable wall mount for screens with a screen diagonal between 32 and 55" (81 - 140 cm).

The VESA universal mount is compatible with screens from at least VESA 100 x 100 mm to a maximum of VESA 400 x 400 mm.

With a wall distance of just 30 mm, the BL Superslim Tilt 400 more than lives up to its name.

A subsequent height adjustment (± 8 mm) is possible on both sides, completely independently of each other by using adjusting screws.

The wall mount can be tilted to 0 or +12° and is available in black.

The surface is finished with a solvent free, impact and scratch resistant powder coating and is therefore particularly carefree.

The quick release device on the back via rope-drawn spring-loaded latch is invisibly fixable at the mount thanks to the included magnets.

The max. load is 35 kg.



incl. spirit level for a precise alignment of the screen



release device with magnets invisibly lockable on the mount



simple release mechanism

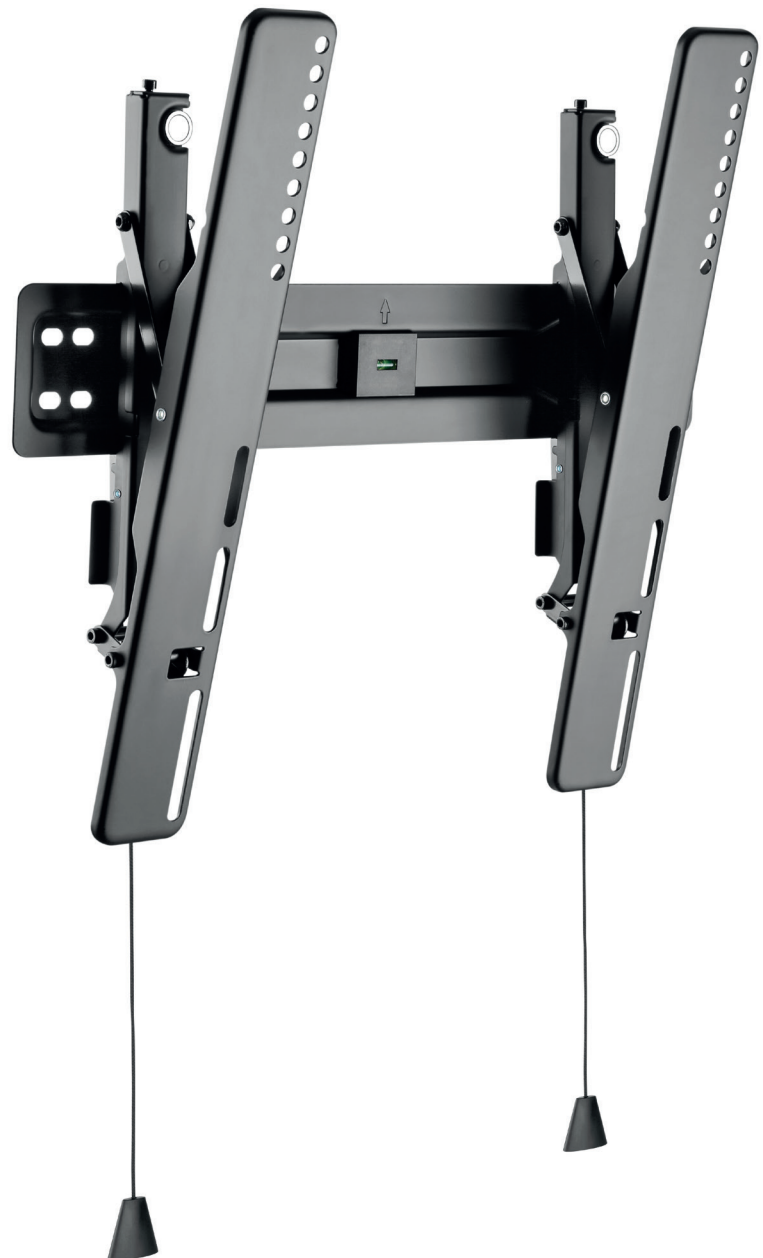

BL Superslim Tilt 400

Tiltable wall mount

Item no.: 8404

- suitable for single screens 32 - 55" | 81 - 140 cm
- incl. VESA universal mount, min. 100 x 100 up to max. 400 x 400 mm
- landscape or portrait format possible
- incl. integrated spirit level
- 0 / +12° tiltable
- only 30 mm wall distance
- 8 mm height compensation
- incl. quick release device via rope-drawn spring-loaded latch, with magnets for invisible fixing on the wall mount
- 35 kg max. load
- colour: black

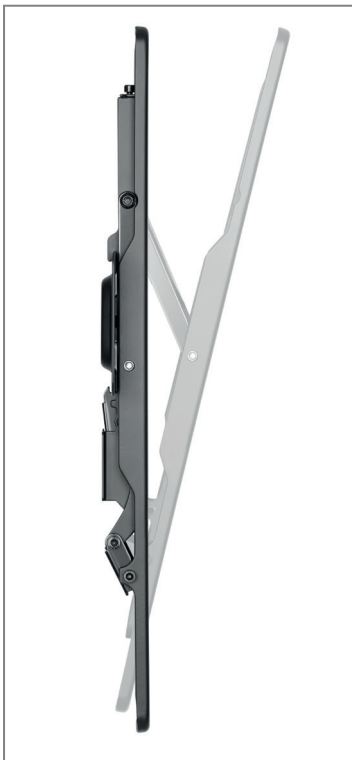

tilt angle 0 or +12°



height compensation ± 8 mm

